



Jamie Edindjikian

Yale School of Architecture
M.Arch II Candidate, 2017

portfolio

JAMIE EDINDJIKLIAN

(516) 672-3368
JAMIE.EDINDJ@GMAIL.COM
408 Washington Boulevard
Long Beach, NY
11561
+
+
+
+
JAY-me ED-in-JICK-LEE-inn

TOOLS:

3D Software: Maya, Rhinoceros, Grasshopper, ZBrush, Google Sketchup
2D Software: AutoCAD, Vectorworks, ArcGIS, QuickBooks
Adobe Suite: Photoshop, Illustrator, InDesign, Premiere
Microsoft Suite: Word, Excel, PowerPoint
Hand: Drawing, Drafting, Painting
Eye: Site surveying

EDUCATION:

Yale School of Architecture
M. Arch II Candidate, 2017. 2015–present
CUNY Macaulay Honors College at The City College of New York 2008–2013
Spitzer School of Architecture at The City College of New York 2008–2013
B. Arch, Magna Cum Laude. Dean's List
Pratt PreCollege Summer Program 2007

ACADEMIC EXPERIENCE:

Yale School of Architecture, Teaching Assistant
+ History of Landscape Architecture: Antiquity to 1700 in Western Europe, Professor Warren B. Fuermann 2016
+ History of British Landscape Architecture, Professor Warren B. Fuermann 2016

SSA at CCNY, Teaching Assistant
+ 2nd Year Undergraduate Design Studio, Professor Nandini Bagchee 2012
+ 3rd Year Undergraduate Design Studio, Professor Elisabetta Terragni 2011–2012
+ 3rd Year Undergraduate Curriculum Coordination, Professor Elisabetta Terragni 2011–2012

Lecturer, 2014

Invited to speak to current students about my work and experiences as a former student in the comprehensive design studio and recent graduate of the B. Arch program

Supporting Editor, 2012–2013

Informality Student Journal, The City College of New York

CCNY Women's Volleyball, 2008

Scholar Athlete

PUBLICATIONS:

Archdaily.com, Yale School of Architecture 2016
Retrospecta 39, Yale School of Architecture 2016
Informality 7, The City College of New York 2014
CityWorks 5, The City College of New York 2012
CityWorks 4, The City College of New York 2011

HONORS/AWARDS:

Honorable Mention, eVolo 2017 Skyscraper Competition
Second Prize, CTBUH International Student Tall Building Design Competition 2016
H.I. Feldman Nomination, Yale School of Architecture 2016
Rome: Continuity and Change Travel Scholarship, Yale School of Architecture 2016
Fontainebleau School Fine Arts Scholarship, The City College of New York 2013
Sean F. Mellon Memorial Architectural Scholarship, New York State Society of American Registered Architects of New York 2012
OSHA Certification 2011

PROFESSIONAL EXPERIENCE:

MADE LLC (Brooklyn, NY)
Build Summer Intern 2016
Design-build practice that integrates architect and builder throughout the creative process by combining a design studio, fabrication workshop, and contracting team. Systems and workflow design.

SYSTEMarchitects LLC (New York, NY)
Architectural Designer 2014–2015
Innovative practice with a focus on multilayered, overlapping, and intertwining space, that seeks to re-evaluate the relationship between built and natural environments. Design work, DOB filing, site surveying, client meetings, construction management.

J.D. Wilson Construction Corp. (New York, NY)
Construction Manager 2014–2015
Contracting firm specializing in masonry. Presently working on site and in collaboration with SYSTEMarchitects. Schedule and budget writing, contract negotiations, bidding.

Douglas J. Lister, Architect (New York, NY)
Assistant Project Manager 2013–2014
A focus on historic preservation and exterior restoration.

Simino Architects (Brooklyn, NY)
Intern architect. Model building 2012

National Trust for Historic Preservation
Surveyor 2012
Preservation Greenlab Existing Buildings Architectural Survey. Performed field investigations on vernacular structures in Corona, Queens, and Bushwick, Brooklyn, for energy retrofit potential.

MoMA PS1 + HWKN
Young Architects Program Volunteer 2012

NYC School Construction Authority
Summer Internship Program Supervisor 2011
Mentor to high school students interning at architecture and engineering firms throughout New York City. Scheduled biweekly meetings with company contacts to confirm the progress and ensure the experiences for each of 24 interns. Designed and directed workshops on resume writing and college application essays.

NYC Department of Design and Construction
Intern 2010
Project management within the Structures Division. Involved in numerous designs at different phases of construction. Performed both independent office work (change orders, funding request requirements, scope of work texts) and fieldwork (visits to construction sites and architecture firms for biweekly progress meetings).

EXHIBITIONS:

Year-End Exhibition of Student Work, Yale School of Architecture 2016
Rome: Continuity and Change Exhibition, Yale School of Architecture 2016
Year-End Exhibition of Student Work, The City College of New York 2013

CONTENTS

Mind the Edge — Post-Pro Design Studio. Fall 2015

Ritualized Interior / Marfa Midterm — Advanced Studio. Spring 2017

A Salvaged Space — Fourth Year Undergraduate Design Studio. Spring 2012

Formal Analysis — 2015

Sugar Hill Cafe — 2014

Spiritual Colloquy — Fifth Year Undergraduate Design Studio. 2012-2013

Haptic Permutations — 2009

Papahānaumokuākea — Advanced Studio. Fall 2016

187F — 2014-2015

Guggenheim Helsinki — 2014

High Density Urban Order — Advanced Studio. Spring 2016

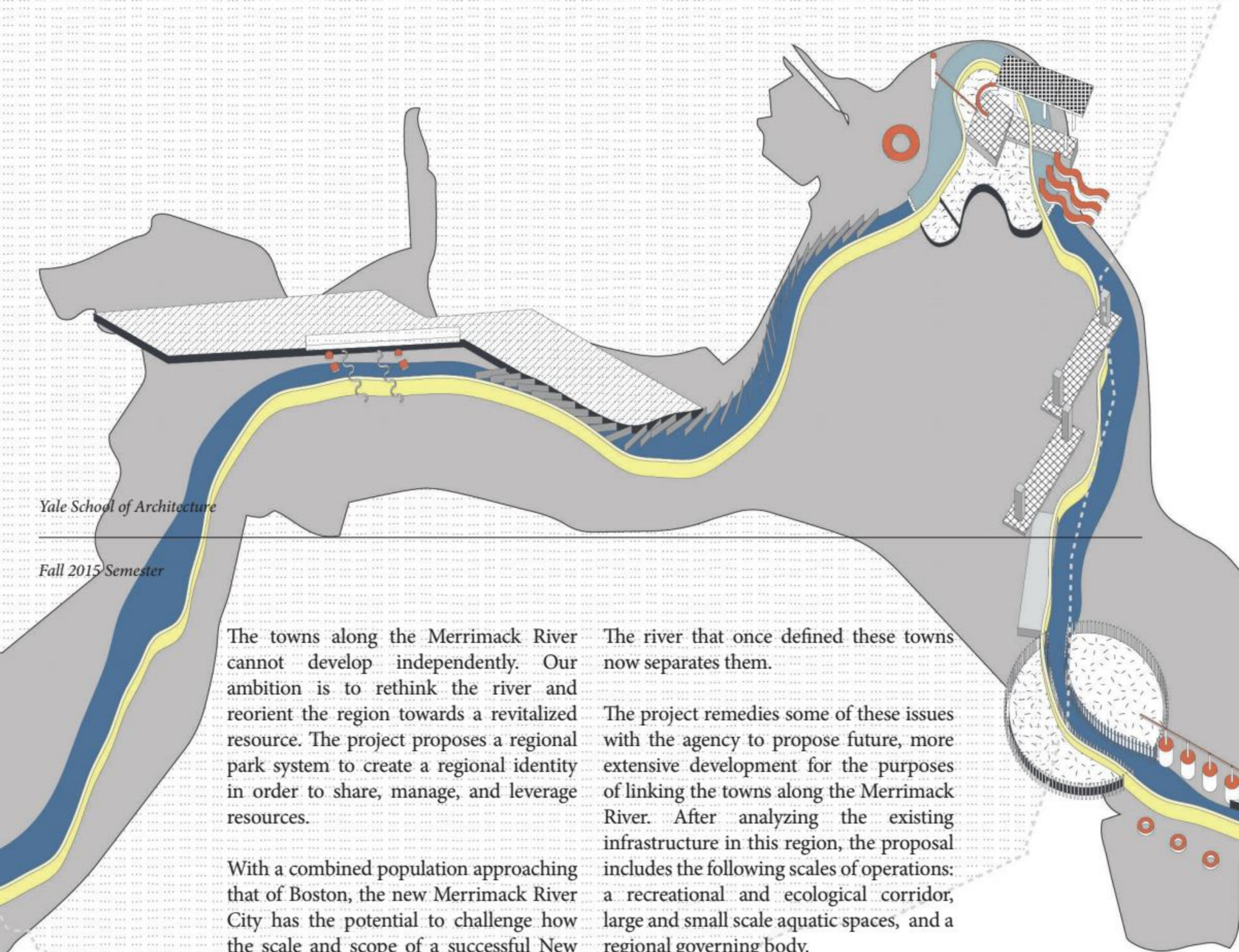

Yale School of Architecture

Fall 2015 Semester

The towns along the Merrimack River cannot develop independently. Our ambition is to rethink the river and reorient the region towards a revitalized resource. The project proposes a regional park system to create a regional identity in order to share, manage, and leverage resources.

With a combined population approaching that of Boston, the new Merrimack River City has the potential to challenge how the scale and scope of a successful New England city performs. The Merrimack River, which runs 118 miles from New Hampshire to Massachusetts has been navigated and productively used since the seventeenth century. In the current economy, the towns along the Merrimack River are struggling; and most of these towns are at the end of rail lines, serving as bedroom communities whereas they were once cottage industries or large manufacturing centers.

The river that once defined these towns now separates them.

The project remedies some of these issues with the agency to propose future, more extensive development for the purposes of linking the towns along the Merrimack River. After analyzing the existing infrastructure in this region, the proposal includes the following scales of operations: a recreational and ecological corridor, large and small scale aquatic spaces, and a regional governing body.

The strategy addresses the fragmentation of these towns environmentally, culturally, and financially. As a result, the regional identity designed around the river will be used as leverage to share and balance resources, and to protect and improve the ecological and economic future of the entire region.

Matthew Bohne, collaborator

Ed Mitchell + Aniket Shahane, critics

MIND THE EDGE

The Merrimack River City

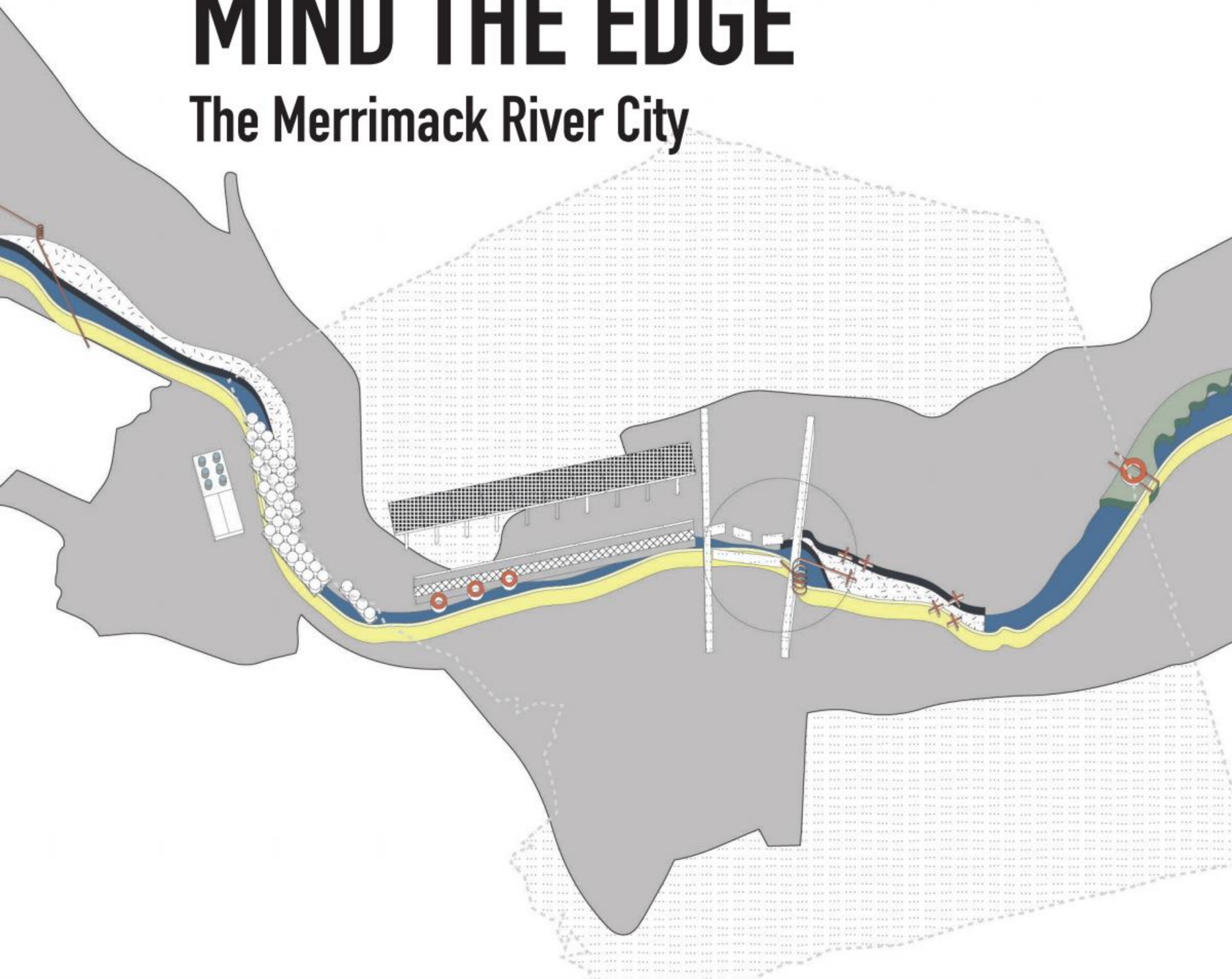



The Merrimack River is one of the navigable rivers of the United States. It varies in width from several hundred feet up to 650-feet, with a depth range of 12 to 32 feet, not considering storm or tidal surges. The river, while historically providing a means of economy to the area, has also contributed to extensive flooding and pollution.

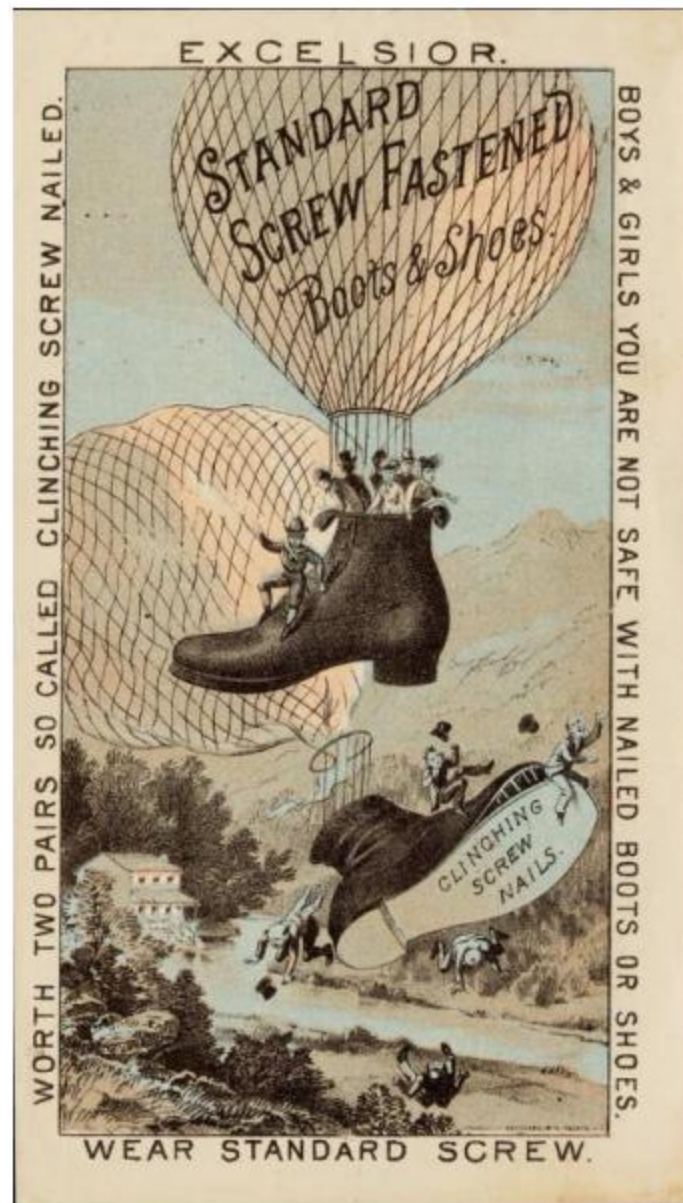

Massachusetts supports various transportation networks. From protected and shared bike paths, rural and urban hiking trails, as well as plane, train, car, and boat networks, the Merrimack River City introduces a vital link in the mobilization of these corridors.

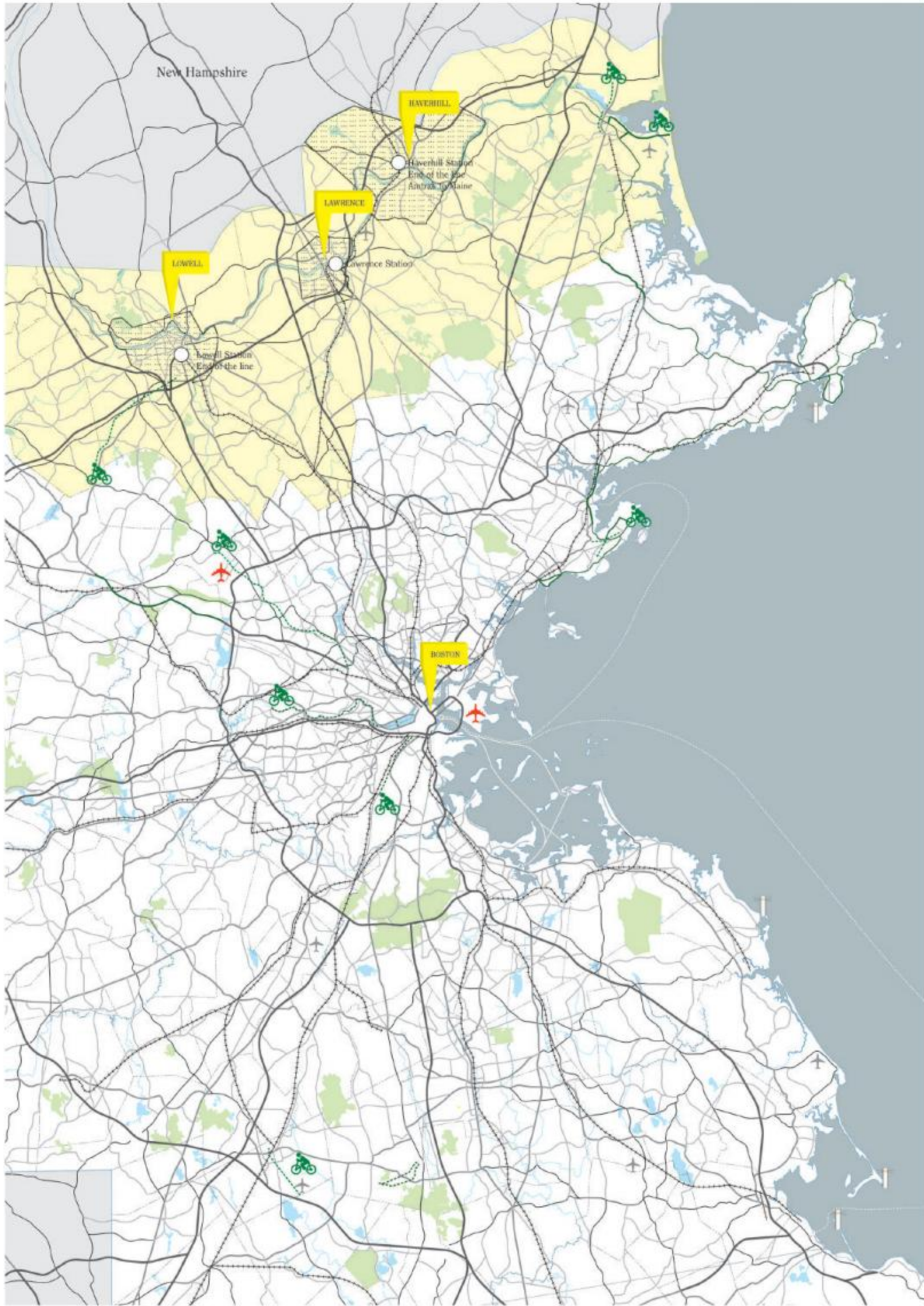

AN ADVERTISEMENT SPONSORED BY

EXISTING NETWORKS

MERRIMACK RIVER CITY

The three part strategy has been developed around the 18-mile section of the Merrimack River. The strategy has the potential to grow the full length of the river, all 118 miles. In this way, the river becomes a productive landscape, a surface that is continually evolving. It is contingent on the growth of its adjacent communities.

AQUATIC COMMONS

The aquatic commons act as a large urban node for the community and give the event islands a place to gather. They also act as significant characters in defining a new relationship to the river.

URBAN ROOMS

The urban rooms are strategically situated along the Merrimack Trail. They act as an interface between the town, the river, and the changing nature as impacted by the presence of the event islands.

TRAIL

The trail physically links one town to another. Contingent upon its context, the trail animates and incites wetland development. It supports recreation and periodic access to the river and its many valuable resources.

EVENT ISLANDS

The twelve event islands each have a unique operation. They move between Lowell and Lawrence, and Lawrence and Haverhill. They temporarily “dock” at the urban rooms along the trail. Here, their character and function may change, as well as the meaning and reading of the urban room.

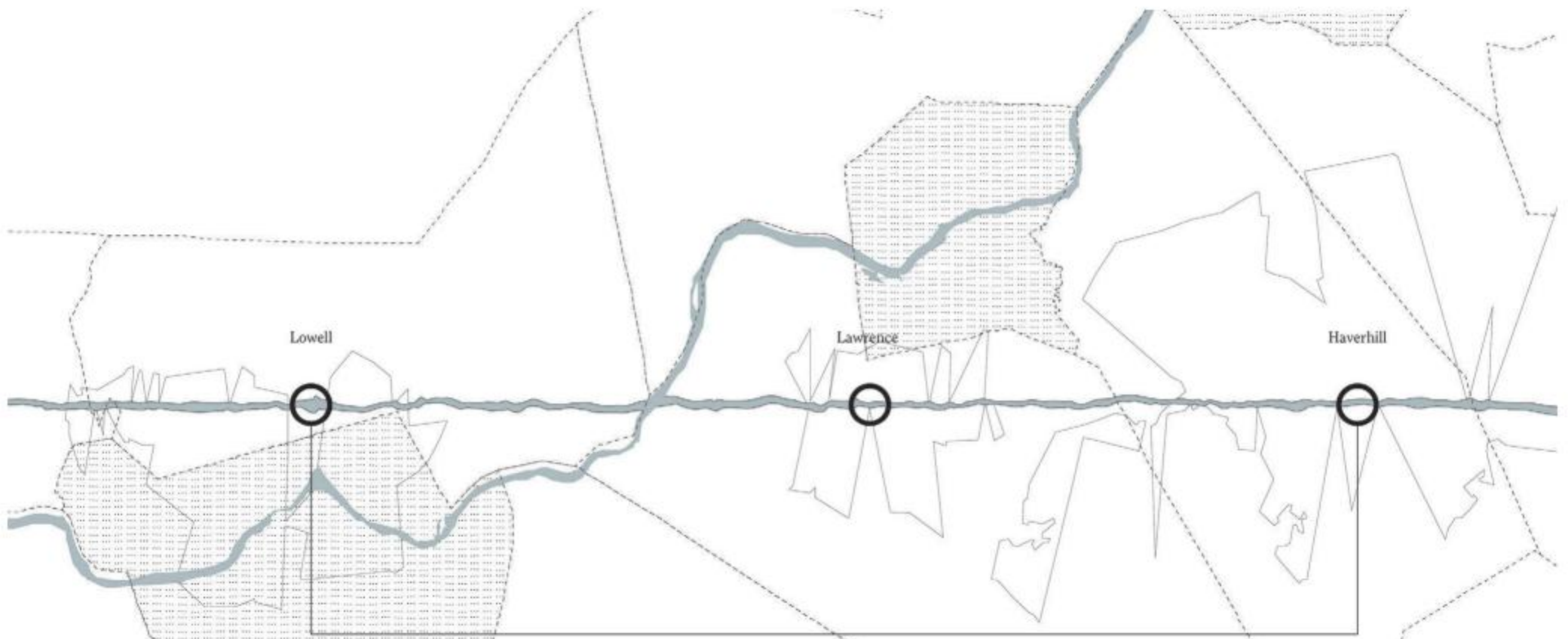

AQUATIC COMMONS

The aquatic commons act as large urban nodes for the community and give the event islands a place to gather. They also act as significant characters in defining a new relationship to the river.

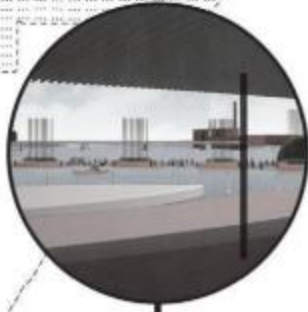

Lowell / Civic



Lawrence / Industry



Haverhill / Arts + Culture

URBAN ROOMS

The urban rooms are strategically situated along the Merrimack Trail. They act as an interface between the town, the river, and the changing nature as impacted by the presence of the event islands.



TRAIL

The trail physically links one town to another. Contiguous on its context, the trail investigates wetland. It supports recreation and periodic access to the river and its many valuable resources.

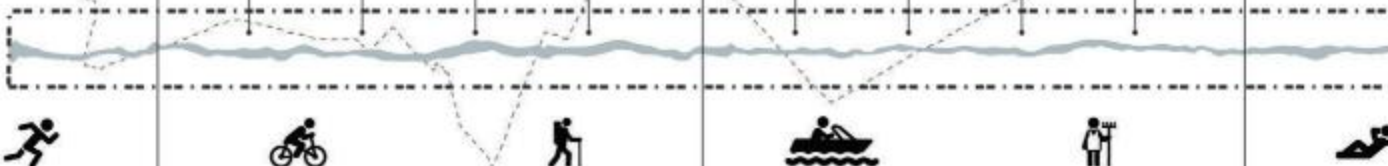

EVENT ISLANDS

The twelve event islands each have a unique operation. They move between Lowell and Lawrence, and Lawrence and Haverhill. They temporarily "dock" at the urban rooms along the trail. Here, their character and function may change, as well as the meaning of the urban room.

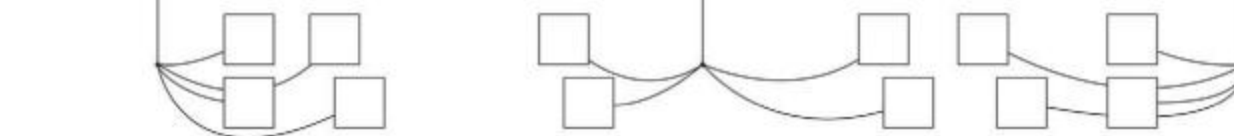

THE TOWNS AND FORUM



The Merrimack River runs for 35-miles in Massachusetts. There are 24 towns along the river with a total population of 635,000. A population (and community) that could rival that of Boston.



A regional "park" system would provide the necessary leverage and be an impetus for each town to work together towards responsible development: a leveraging and sharing of resources. The identity around this physical link would provide good reason to seek local, state, and federal resources.



As a regional entity, a regional chamber of commerce, or forum, would be created to oversee, manage, and conduct research and planning for a future that is invested in economic, cultural, ecological, and environmental prosperity.

AN ADVERTISEMENT SPONSORED BY
REGIONAL STRATEGY
 MERRIMACK RIVER CITY

Pop. 645,966

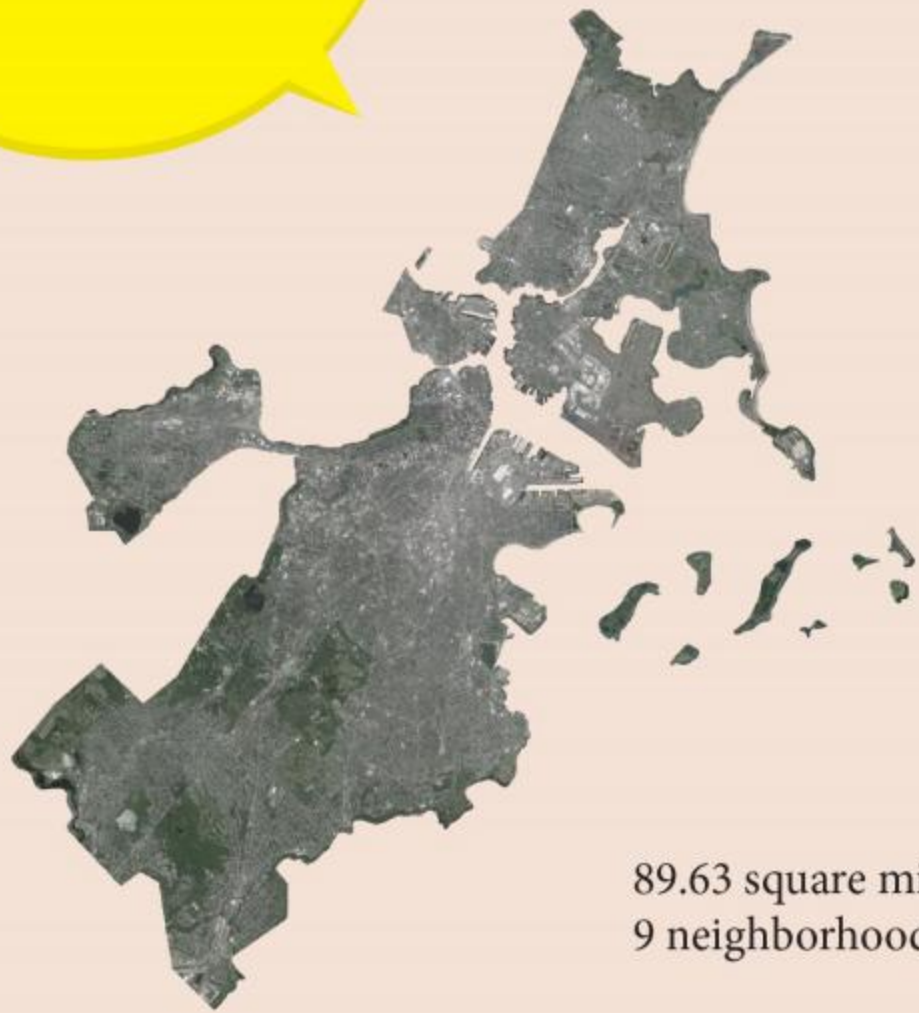

89.63 square miles
9 neighborhoods

Boston, Massachusetts

Pop. 635,270

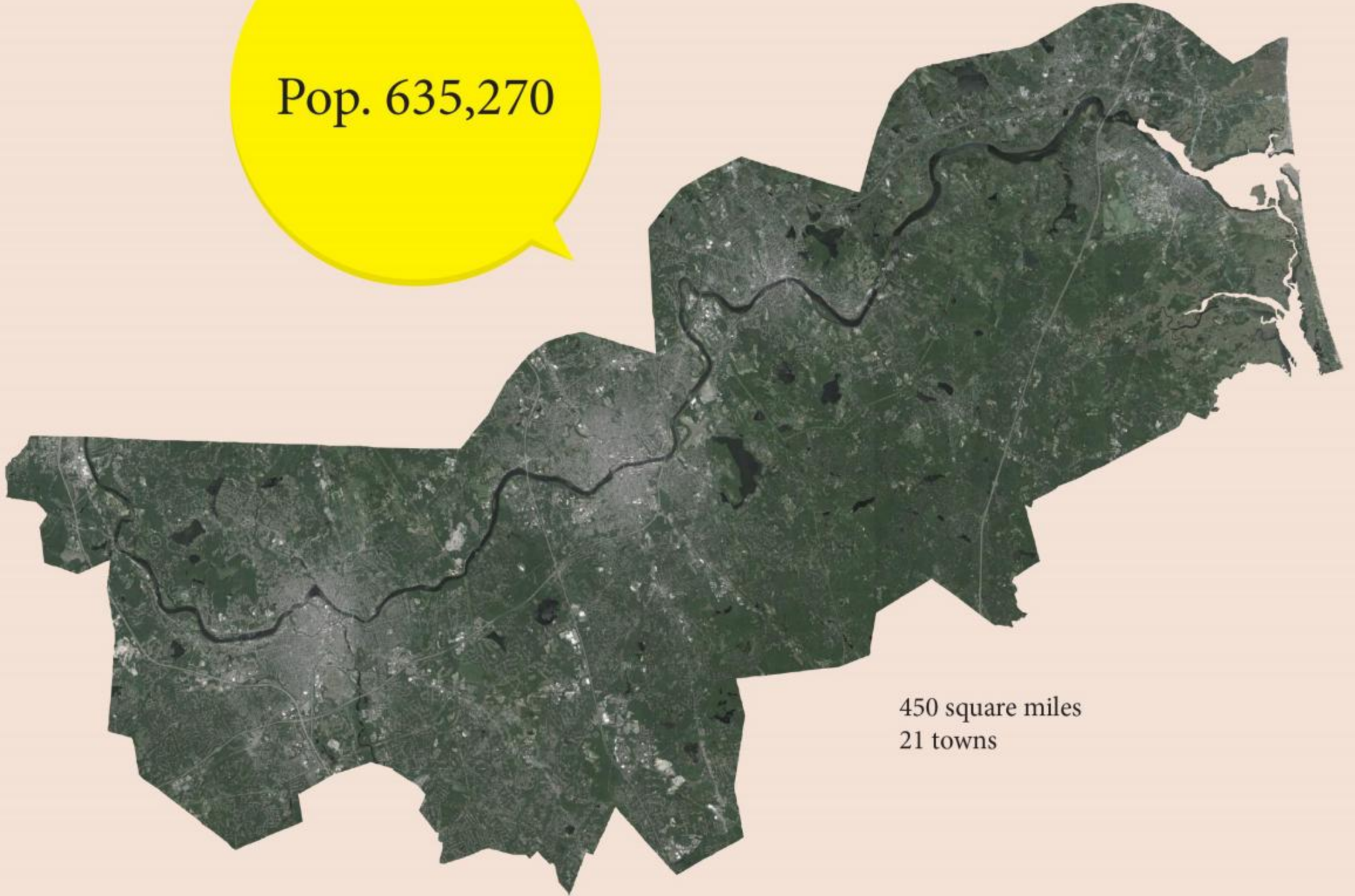

450 square miles
21 towns

Towns along the Merrimack River, Massachusetts

A regional park system would provide the necessary leverage and be an impetus for each town to work together towards responsible development: a leveraging and sharing of resources. The identity around this physical link would provide good reason to seek local, state, and federal resources.

As a regional entity, a regional chamber of commerce, or forum, would be created to oversee, manage, and conduct research and planning for a future that is invested in economic, cultural, ecological, and environmental prosperity.

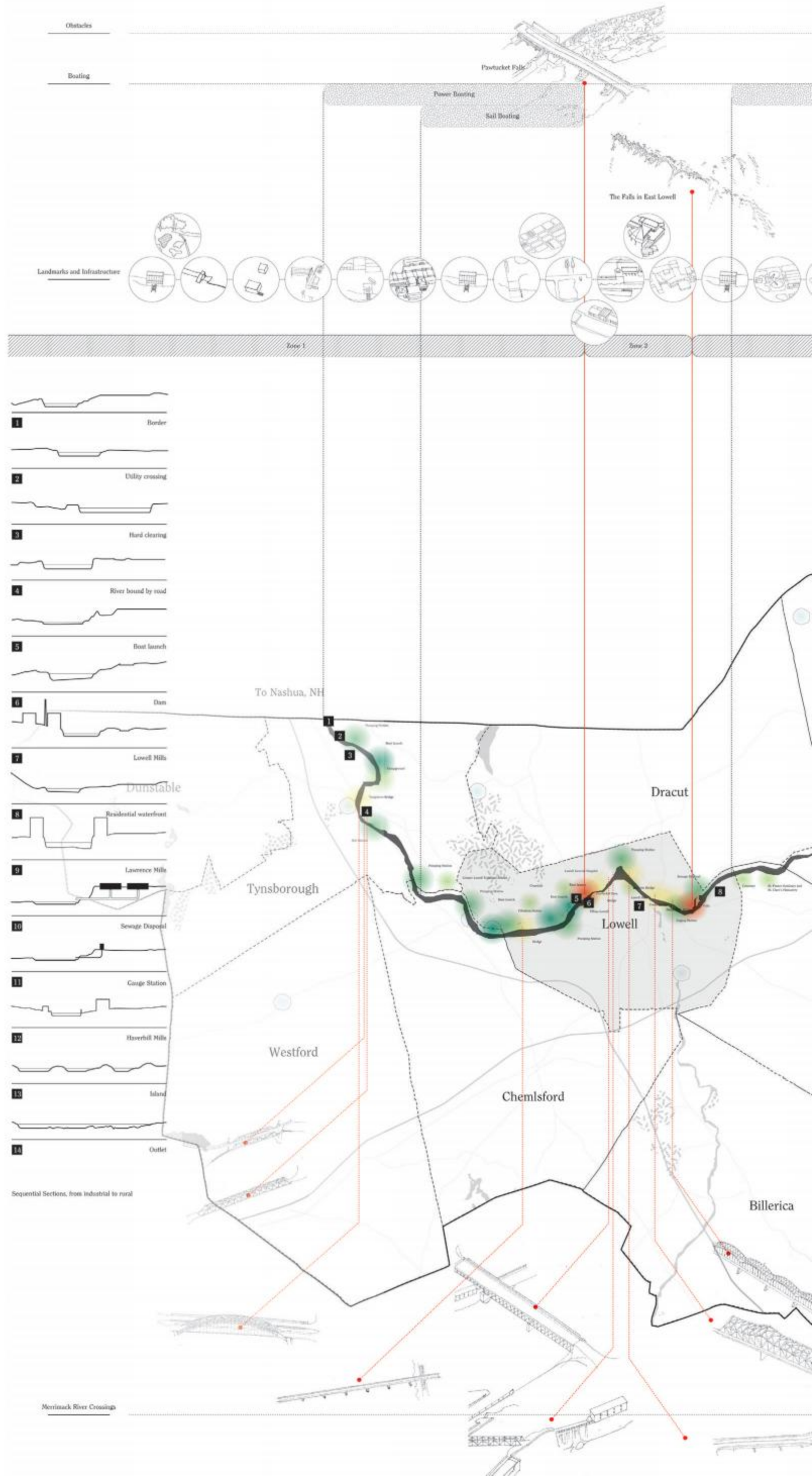

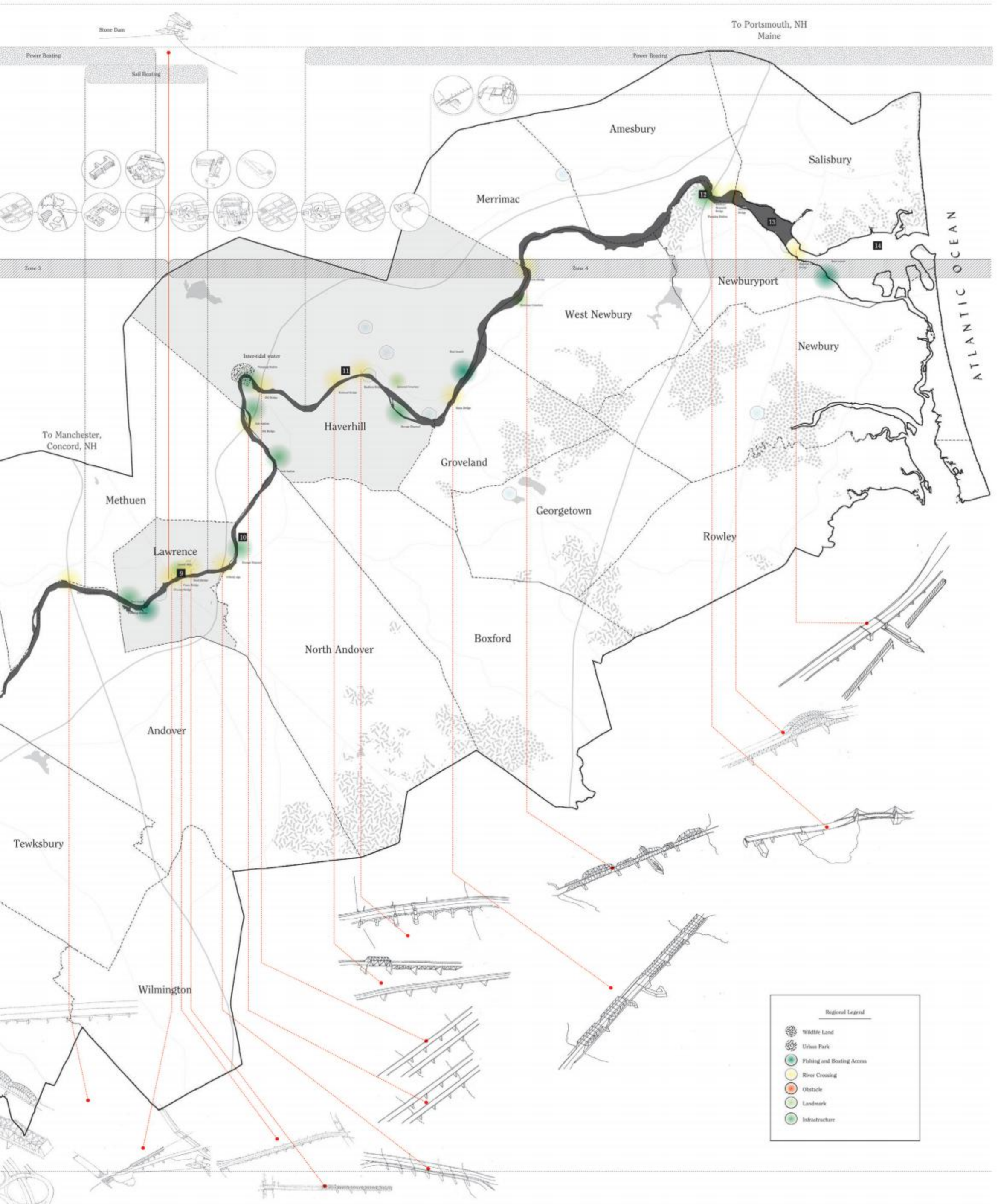

To Portsmouth, NH
Maine

ATLANTIC OCEAN

To Manchester,
Concord, NH

Regional Legend

- Wildlife Land
- Urban Park
- Fishing and Boating Access
- River Crossing
- Obstacle
- Landmark
- Infrastructure

THE TRAVELER IS INVITED TO VISIT THE CITY AND,
AT THE SAME TIME, TO EXAMINE SOME OLD PLACARDS
THAT SHOW IT AS IT USED TO BE.



AN ADVERTISEMENT SPONSORED BY

PUBLIC POWER DISTRICT

EST. 1826, REFOUNDED 2015

THE TRAVELER IS INVITED TO VISIT THE CITY AND,
AT THE SAME TIME, TO EXAMINE SOME OLD PLACARDS
THAT SHOW IT AS IT USED TO BE:



AN ADVERTISEMENT SPONSORED BY

PUBLIC POWER DISTRICT

EST. 1826, REFOUNDED 2013

The urban instruments range in scale and scope from a painted surface to a large water-based infrastructures and large scale pedestrian bridges. The use of the instruments is contingent on the current state of the river, the character of the trail, abutting edge condition, and takes into consideration prominent natural and synthetic landmarks.

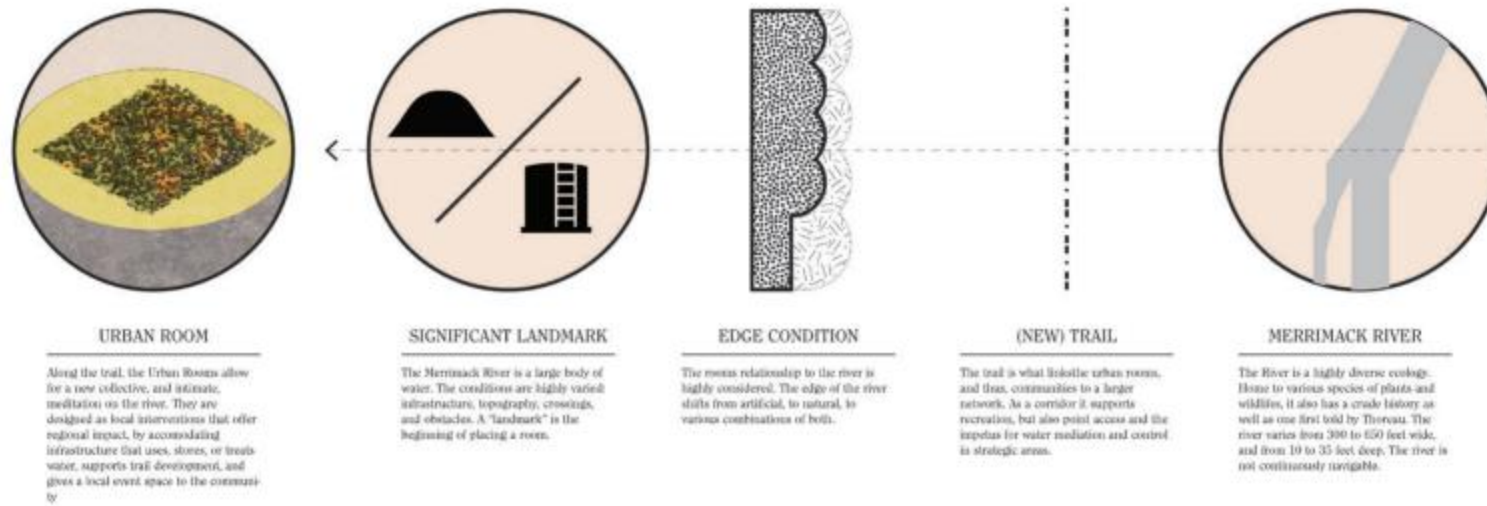

AN ADVERTISEMENT SPONSORED BY
PARTS TO THE PARK SYSTEM
 MERRIMACK RIVER CITY

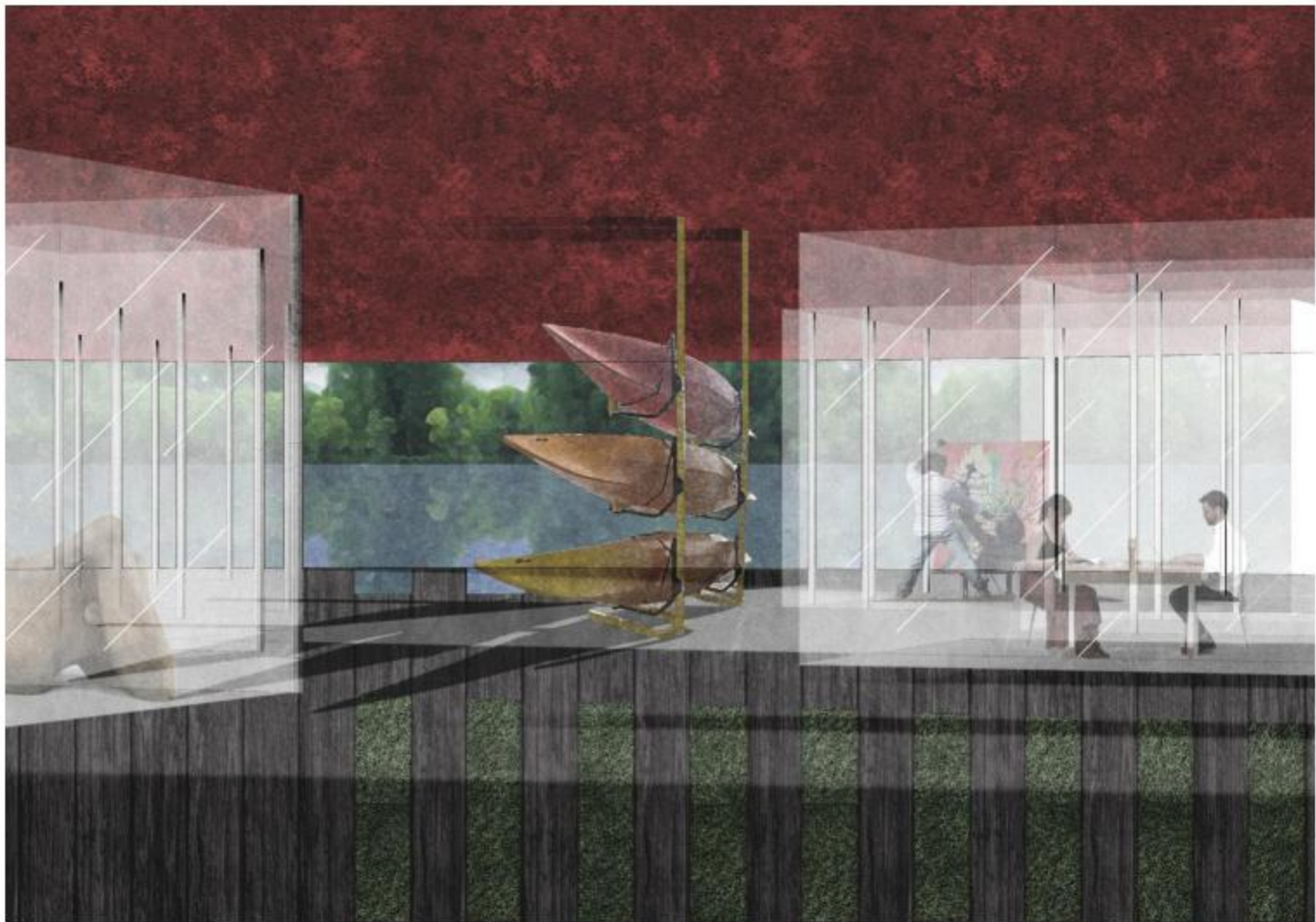
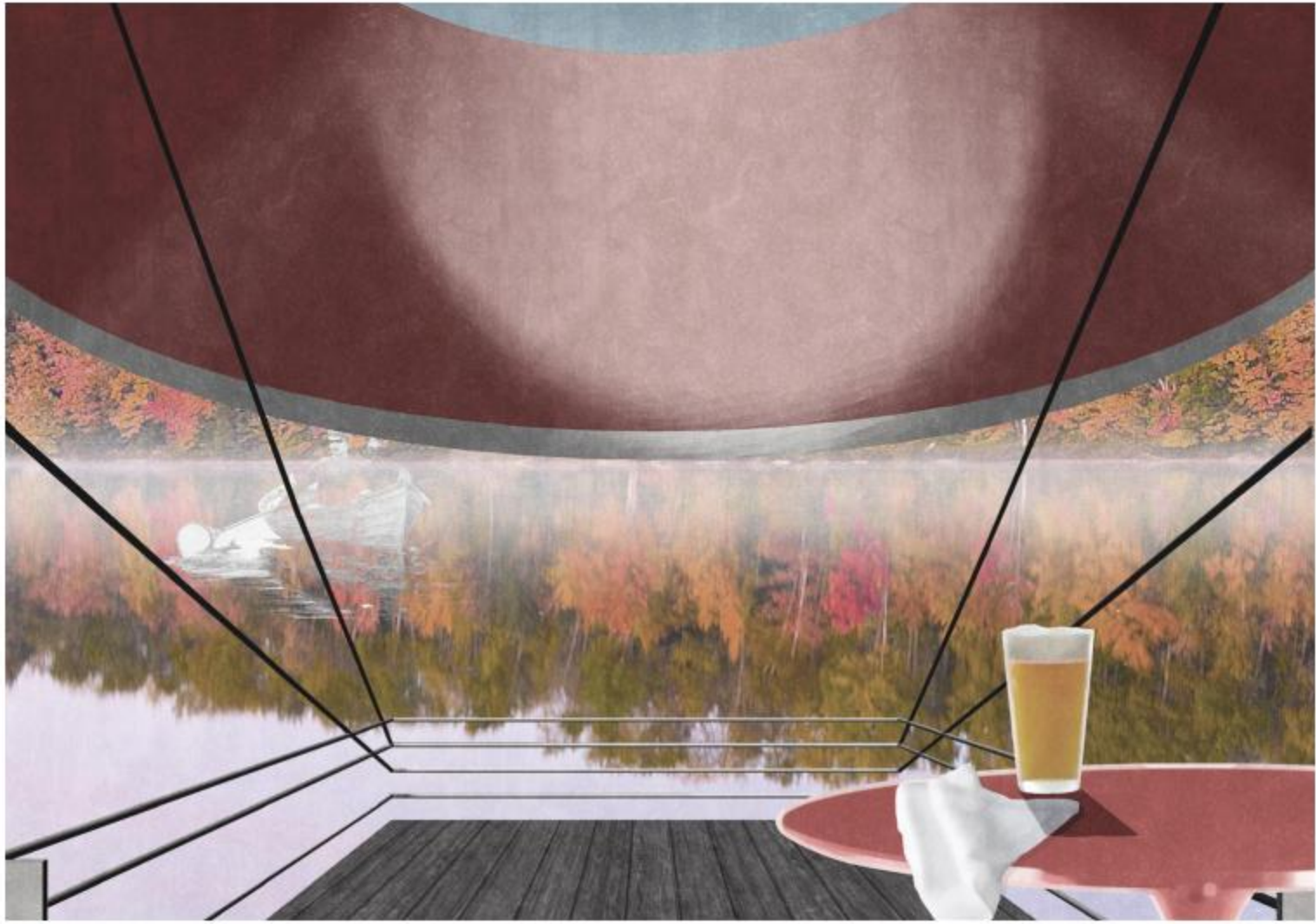

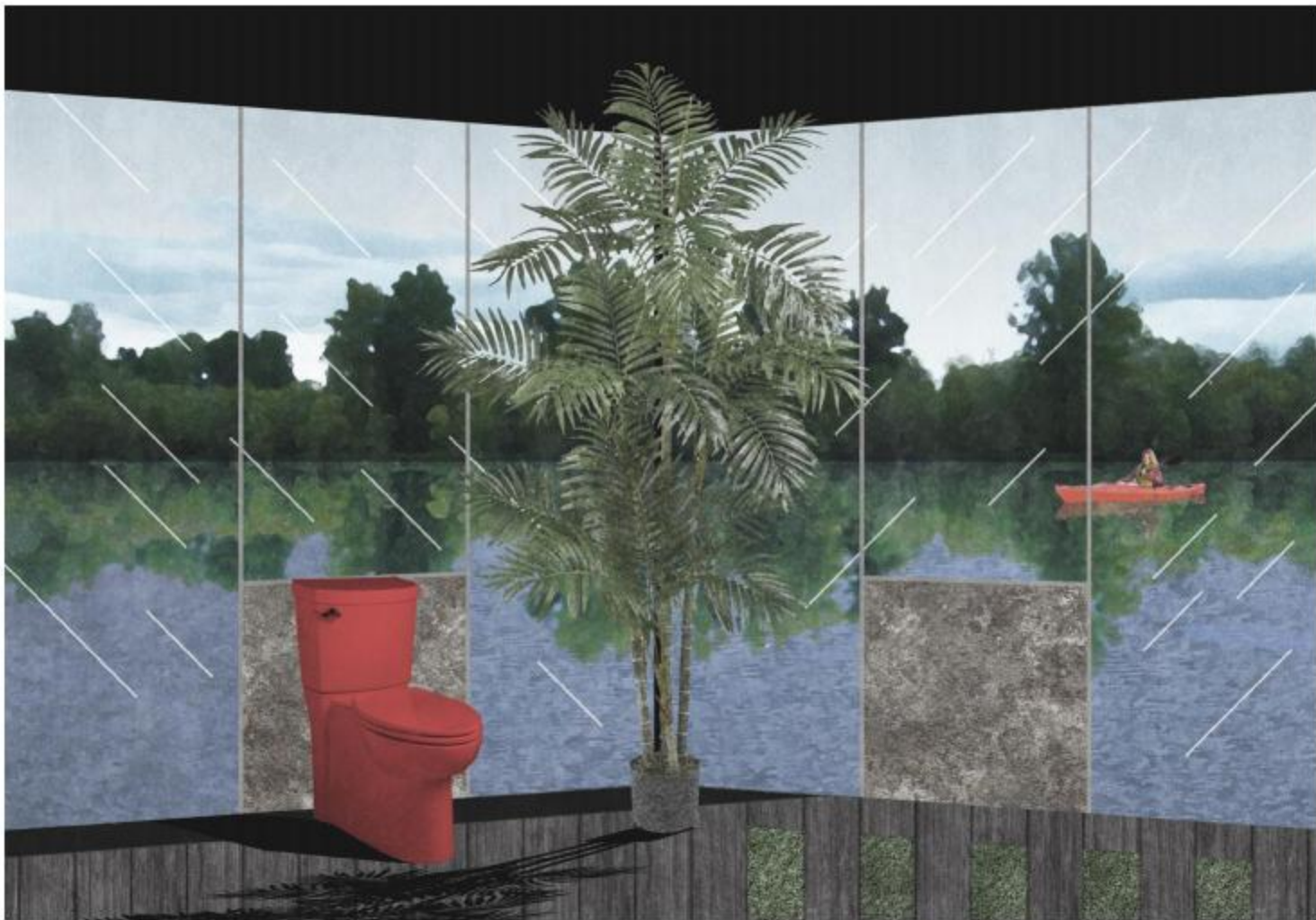

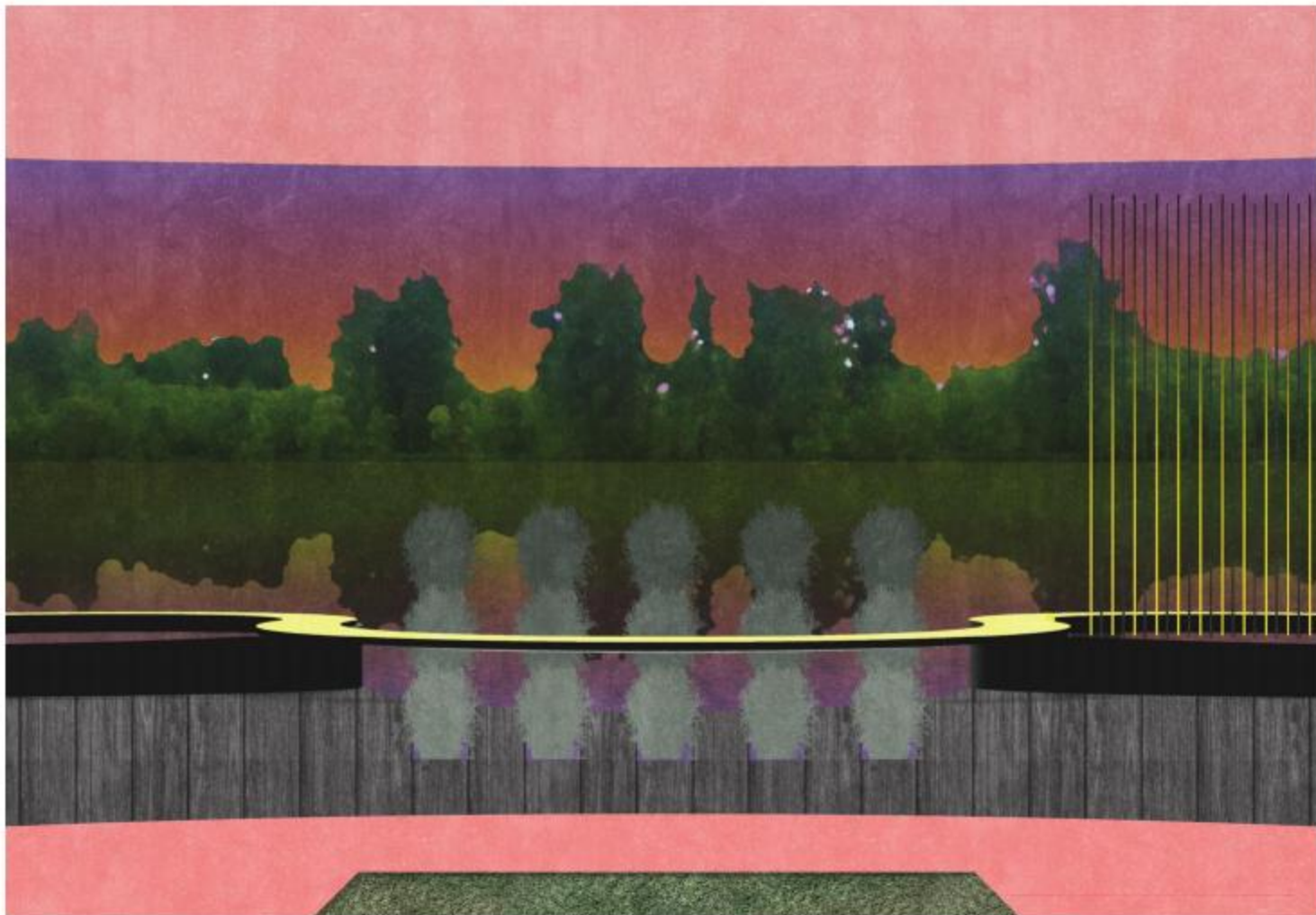
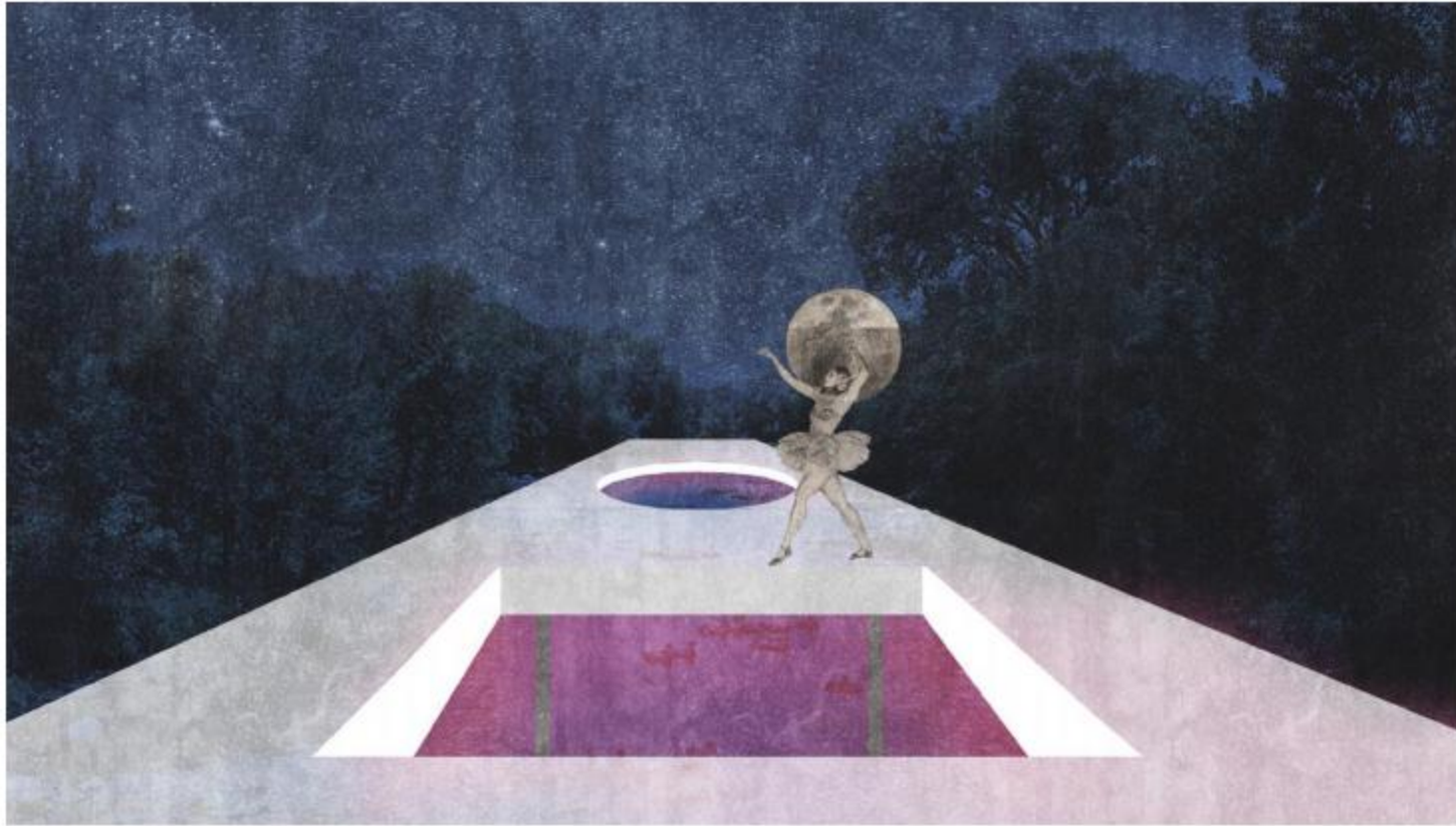

A REGIONAL PARK SYSTEM

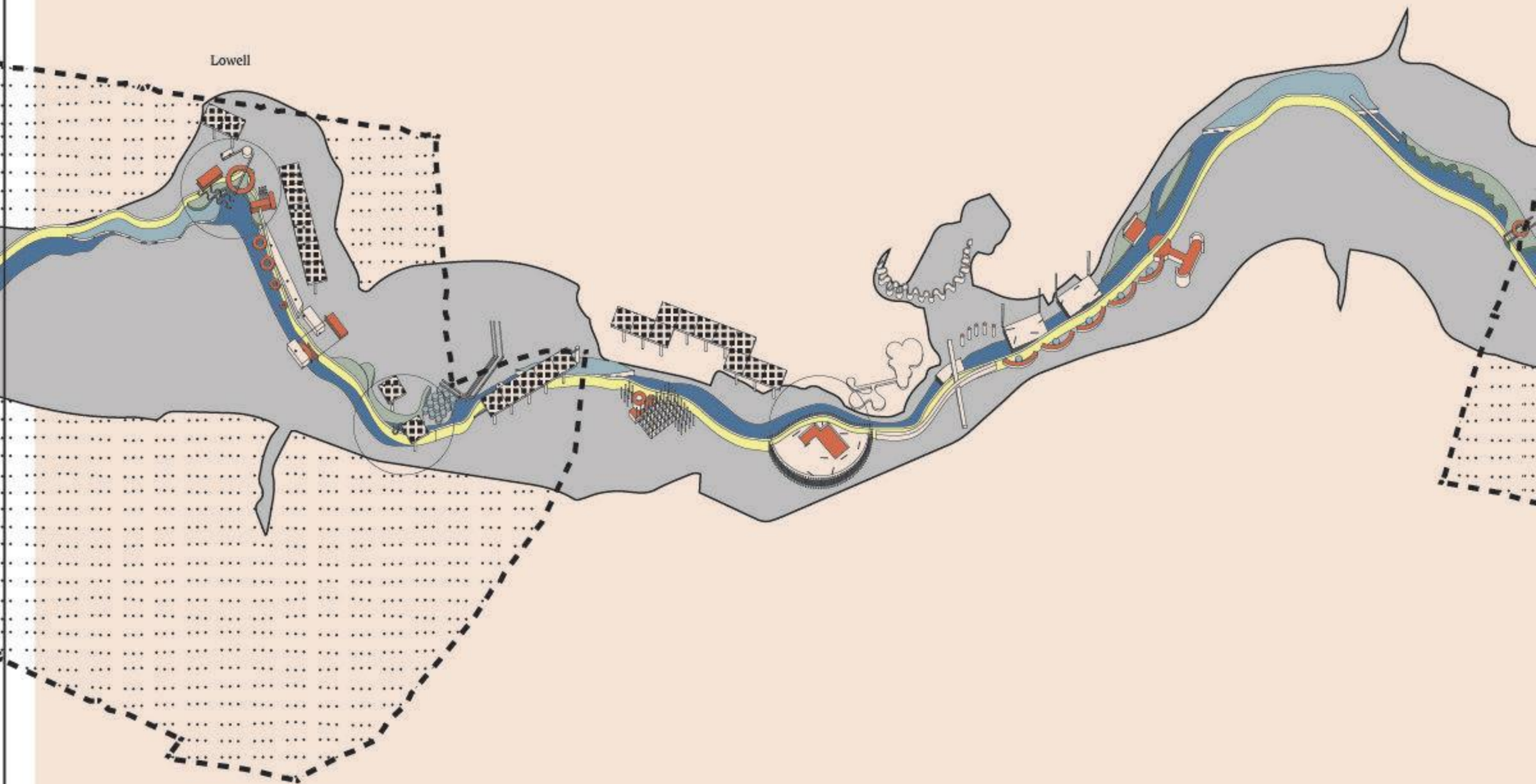

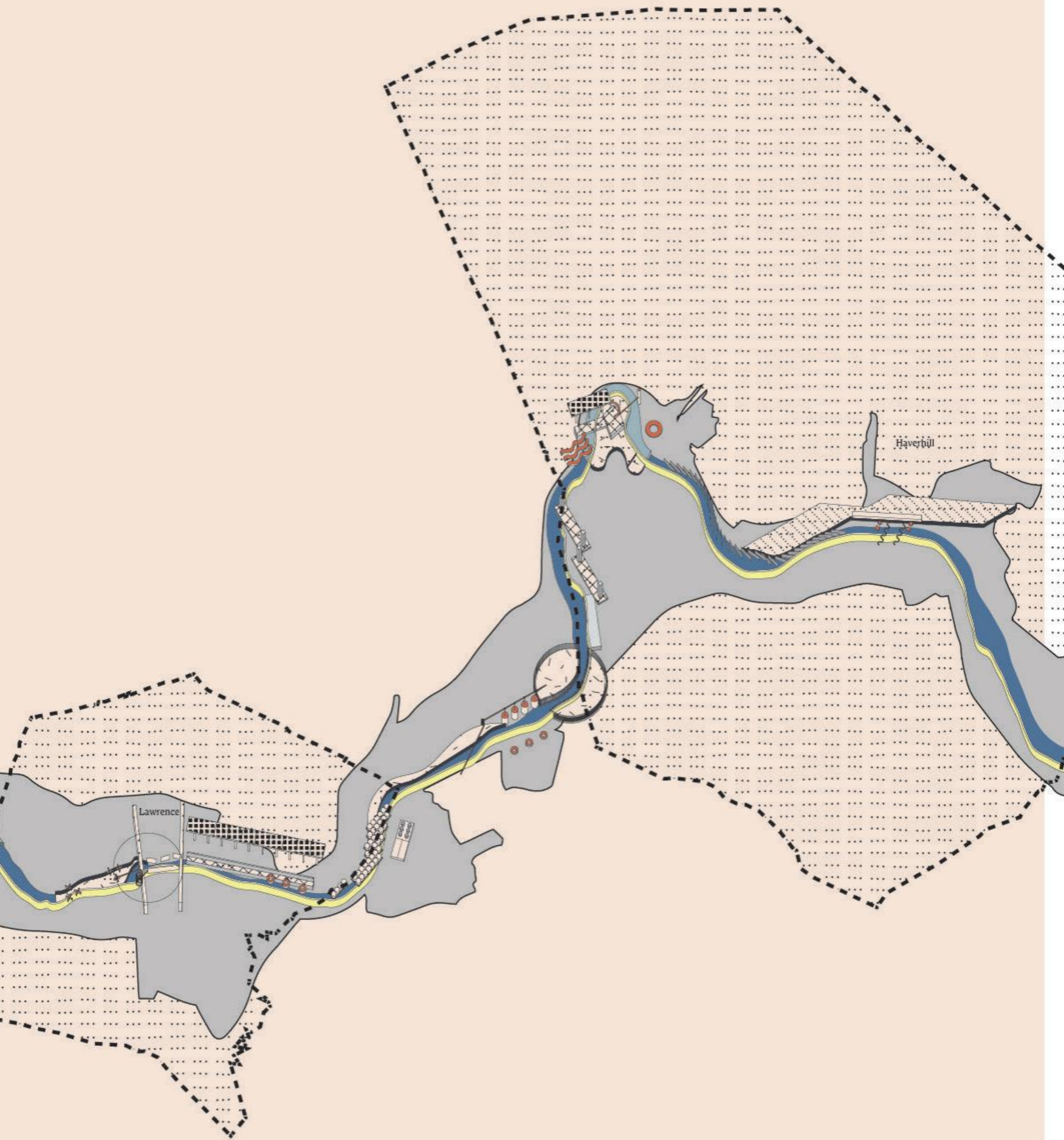

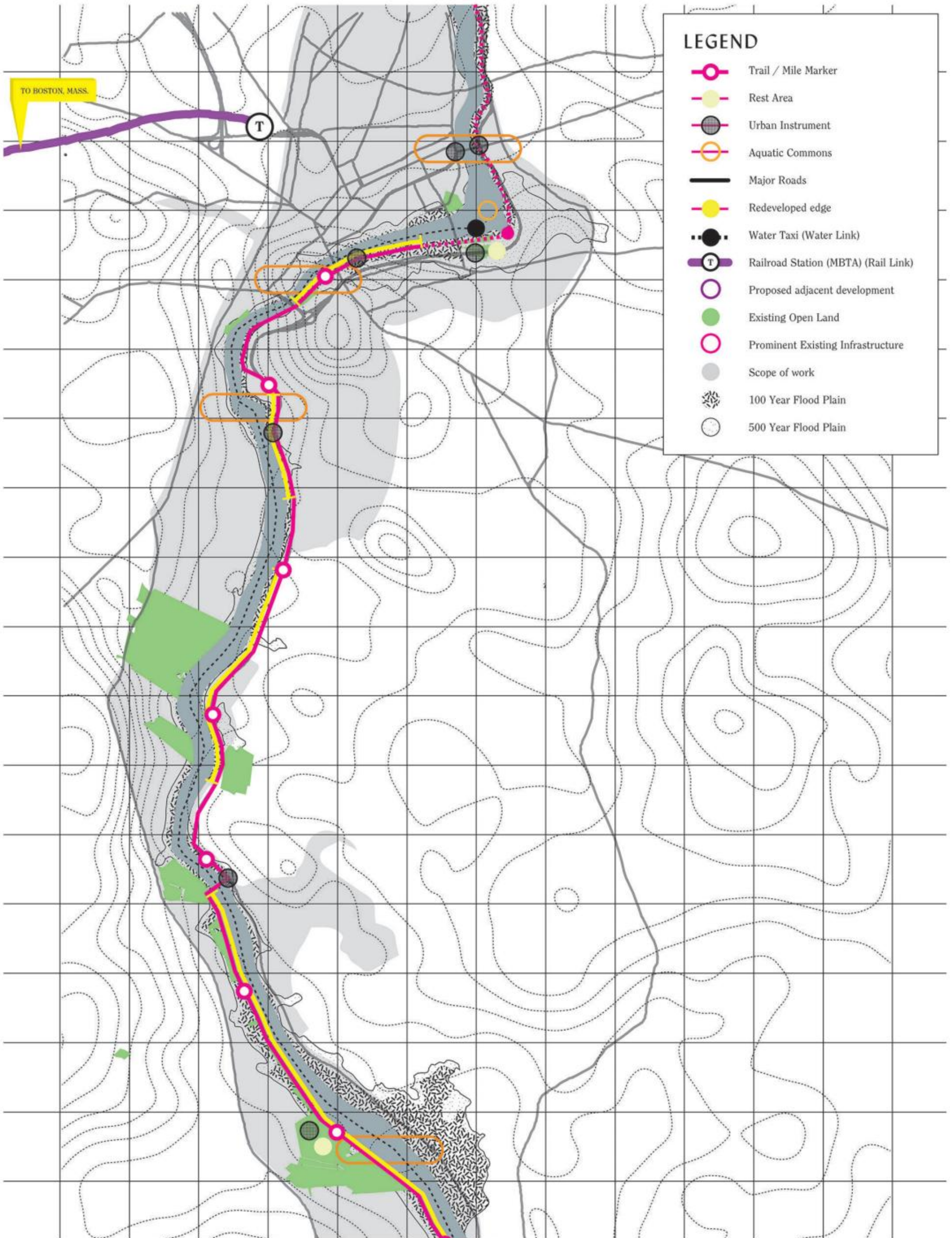

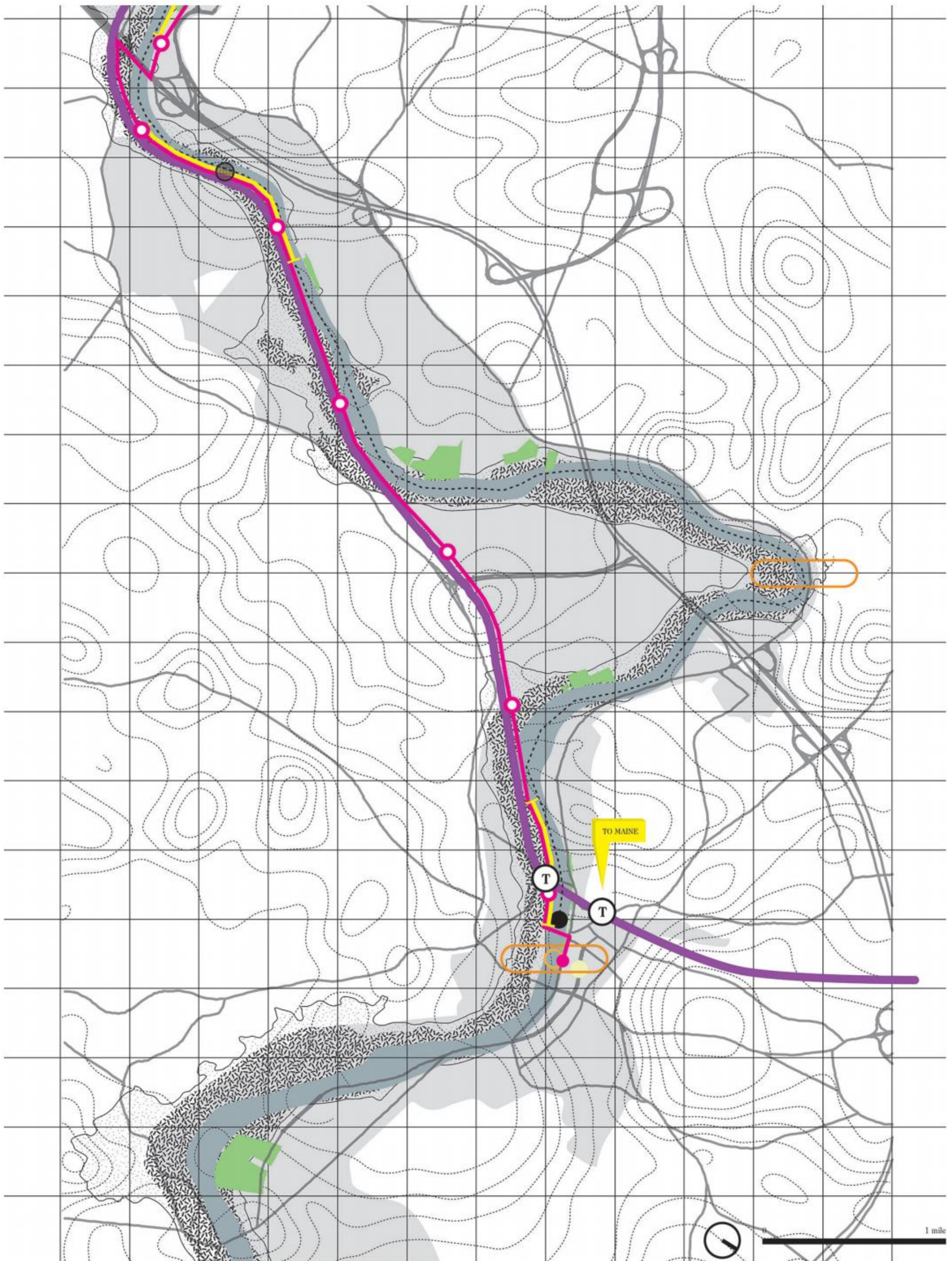

ENERGY SECTOR

This crossing just below the Pawtucket Falls connects two major parallel roads on both sides of the river. A hard edge comprising Lowell's canal system faces out across to a more native edge. The river is bounded on both sides by the institutional grounds of UMass Lowell. We find an overabundance of street parking with potential for new use, and observe abutting areas of high density residential.

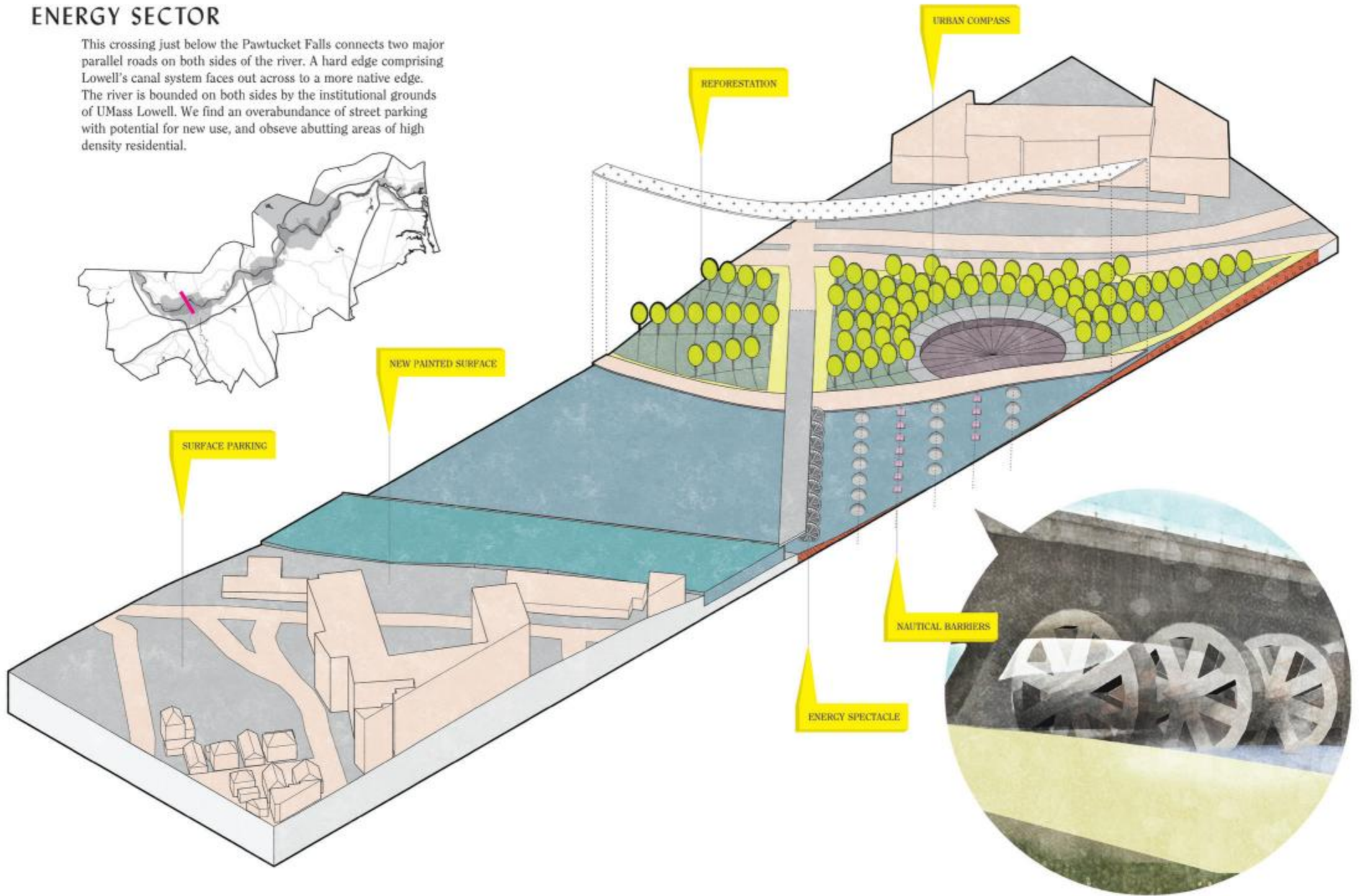

RECREATION SECTOR

Bordered by a pumping station and solar field to the north, this region seeks to mediate between numerous land uses: industrial with high density residential on the north banks, and industrial, manufacturing, and a boat house across the river to the south. With lush forestry and existing natural edges, the site is appropriate for water recreation.

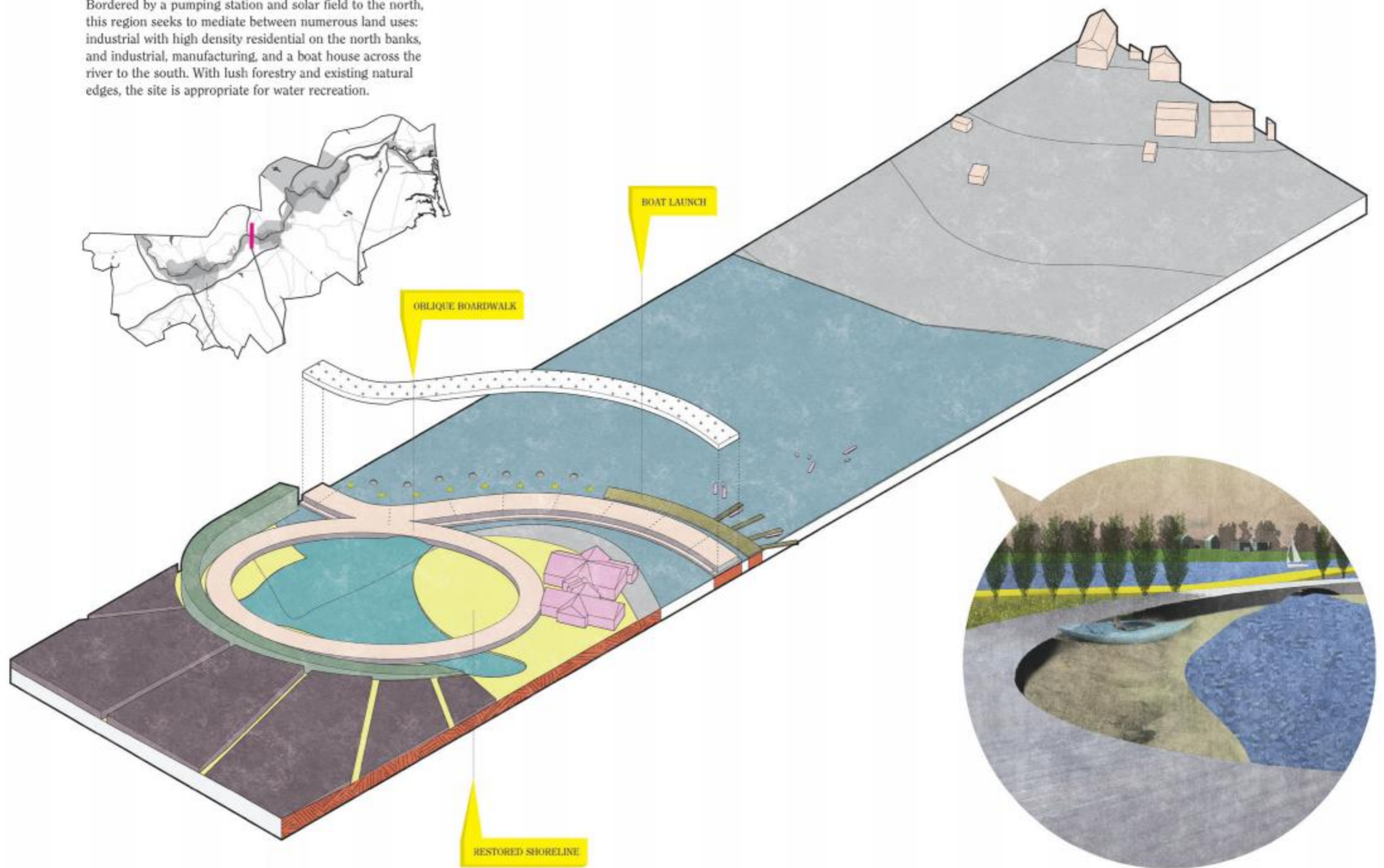

FILTRATION SECTOR

This distillation system taps into an existing water treatment facility. The area contains light manufacturing and agriculture, and acts as an active rail corridor. The section is situated parallel to highway Rte. 110.

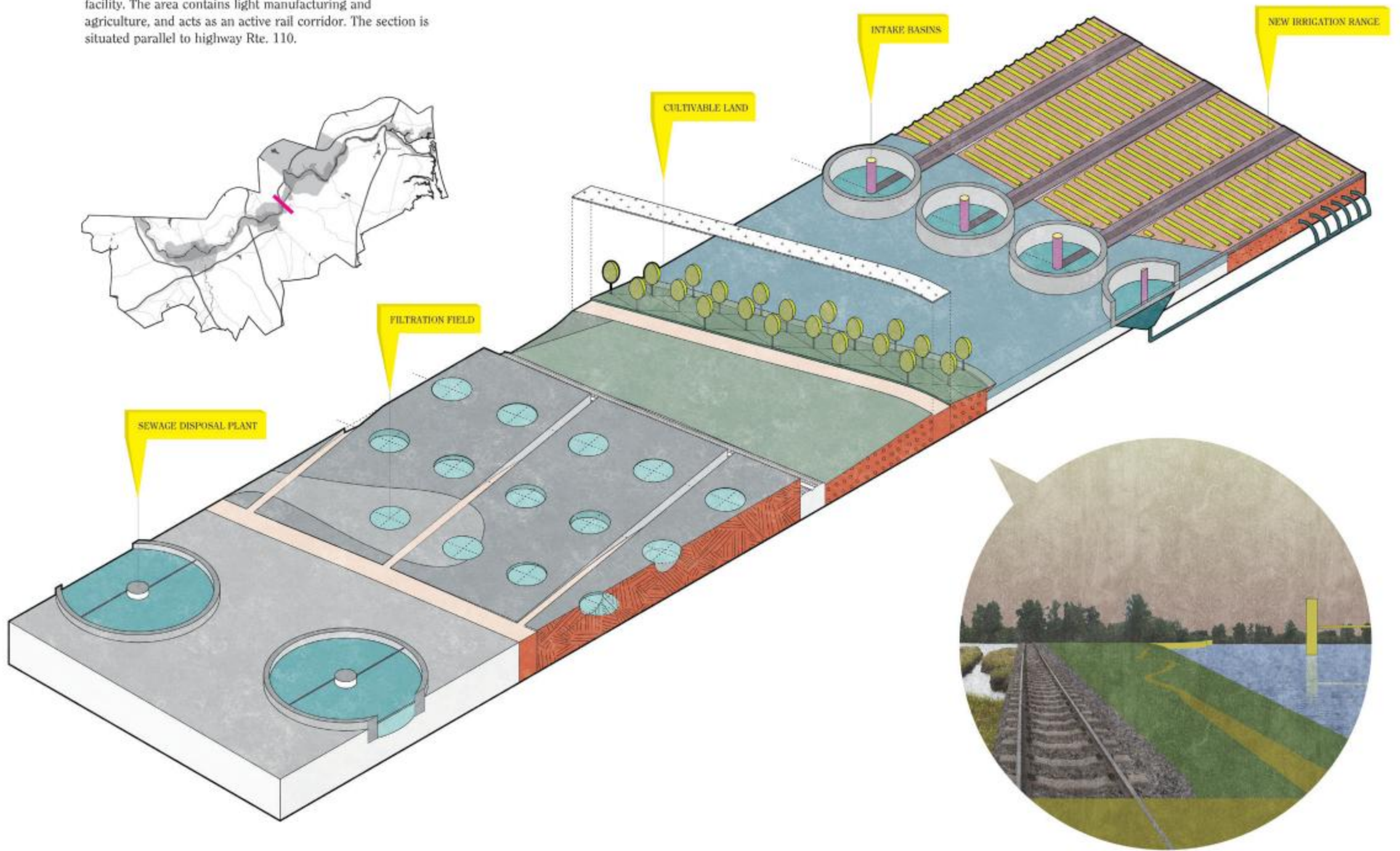

AGRICULTURAL SECTOR

This area occupies the most acute bend in the river, with low density residential standing opposite of a large clearing and hill. The site signifies the tidal changeover from salt water to fresh water. The section is particularly vulnerable and prone to flooding.

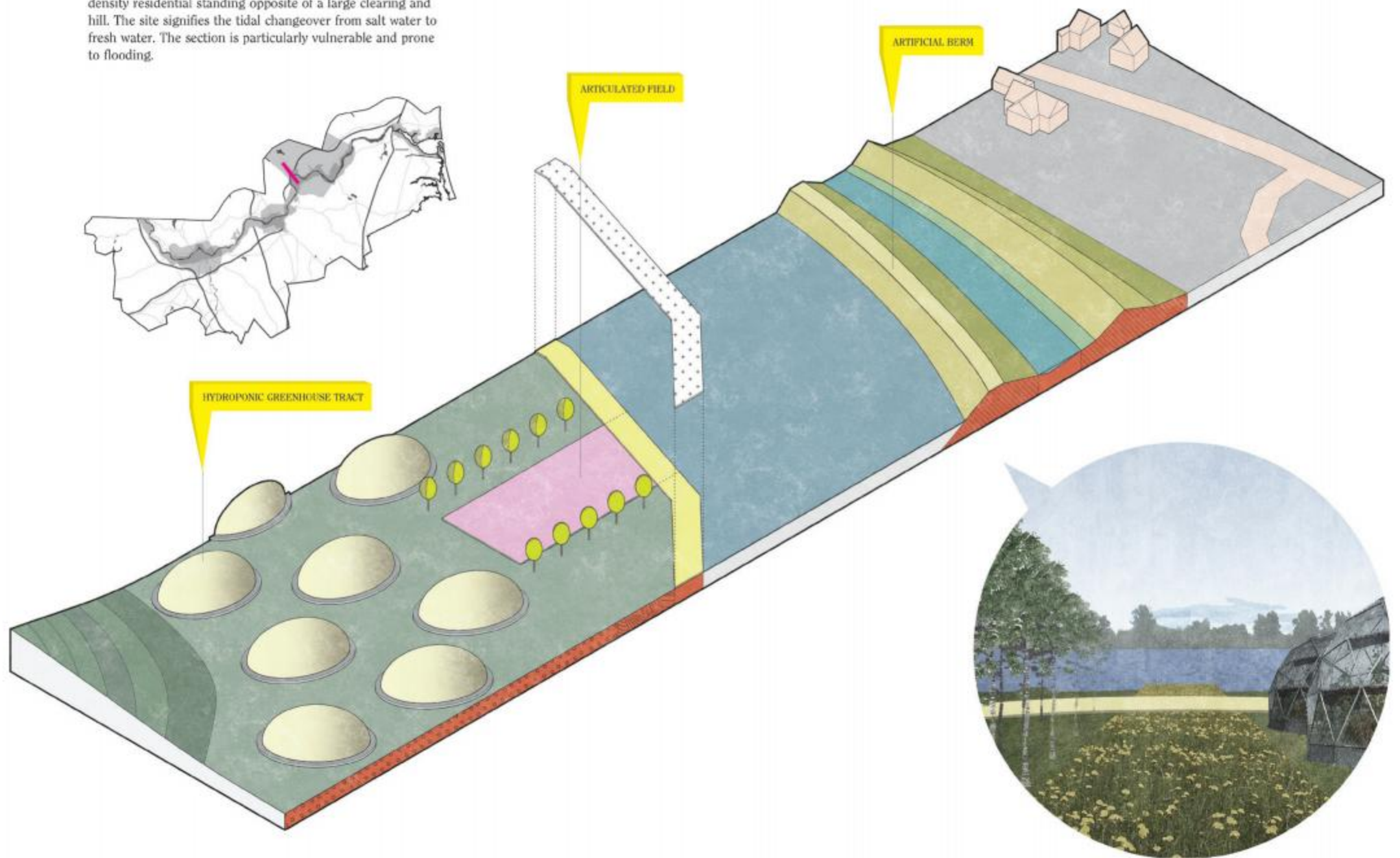

The buoy is a trail marker. Its scale also provides a temporary place to dock a boat or for micro-recreation activities. Along the river, the buoy is placed every 1000 feet, for a total of 95 buoys along the current Merrimack River City. With the ambition to occupy the region, the buoy uses light as a technique, its presence oscillating day to night.

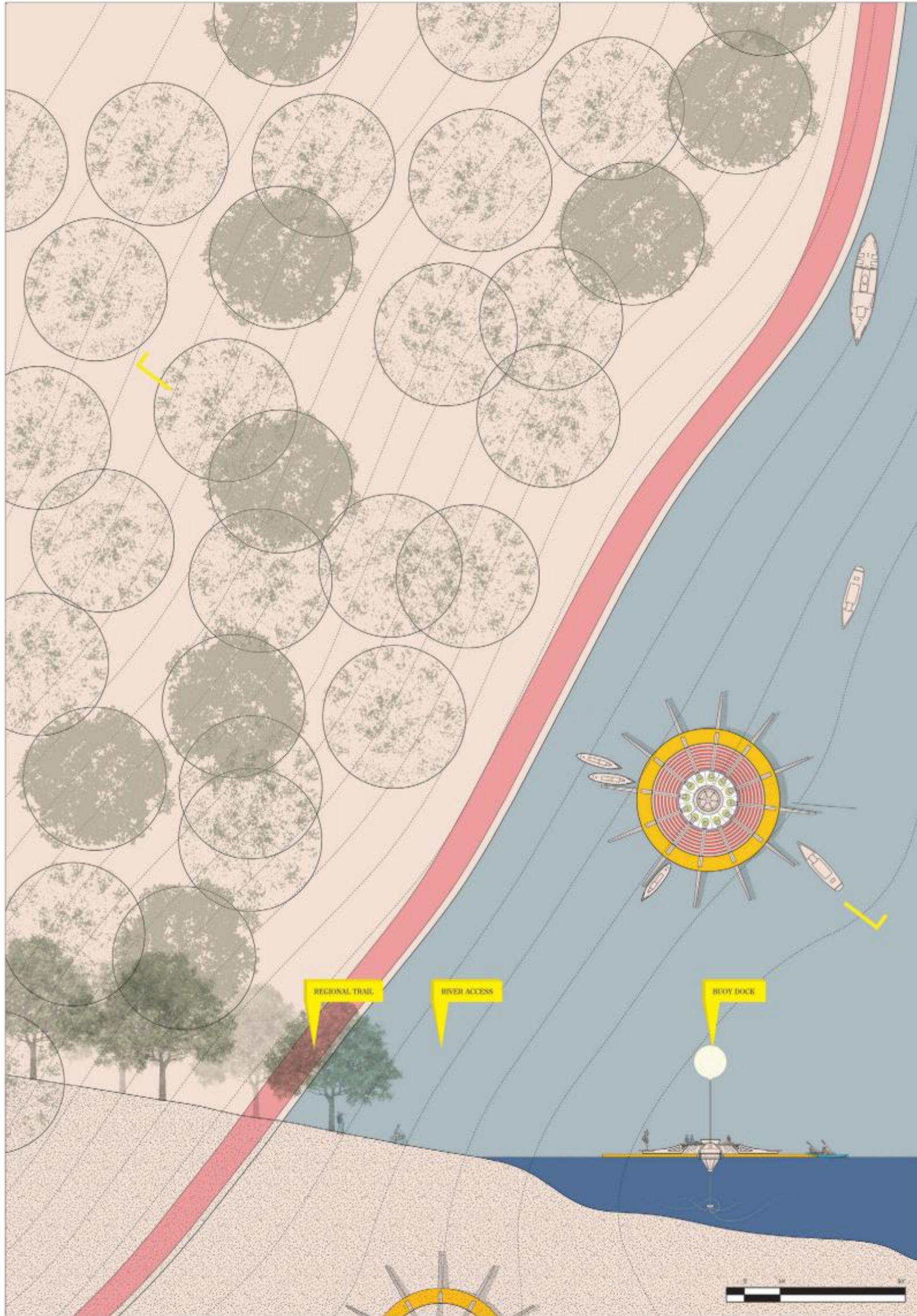
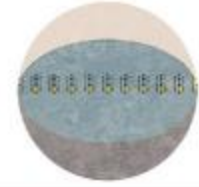

AN ADVERTISEMENT SPONSORED BY
NAVIGATION MARKS
MERRIMACK RIVER CITY

The ambition with the event surface is to acquire under-used and vacant land along the Merrimack River and lay claim to it with the use of surface treatment or the construction of a roof structure. These micro-commons become essential to hold community farmer's markets, flea markets, and serendipitous events determined by community stakeholders.

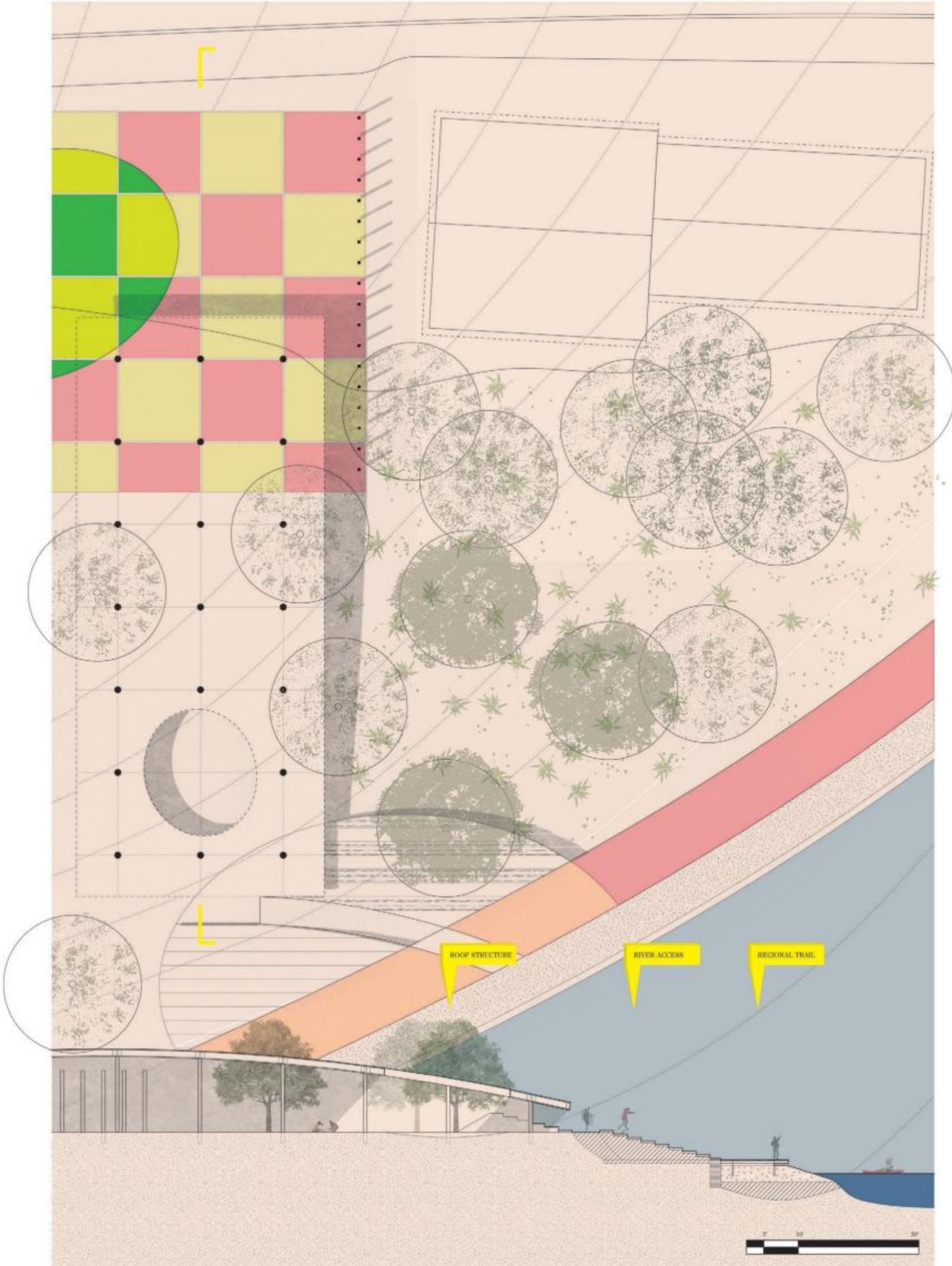

AN ADVERTISEMENT SPONSORED BY
EVENT SURFACE
MERRIMACK RIVER CITY





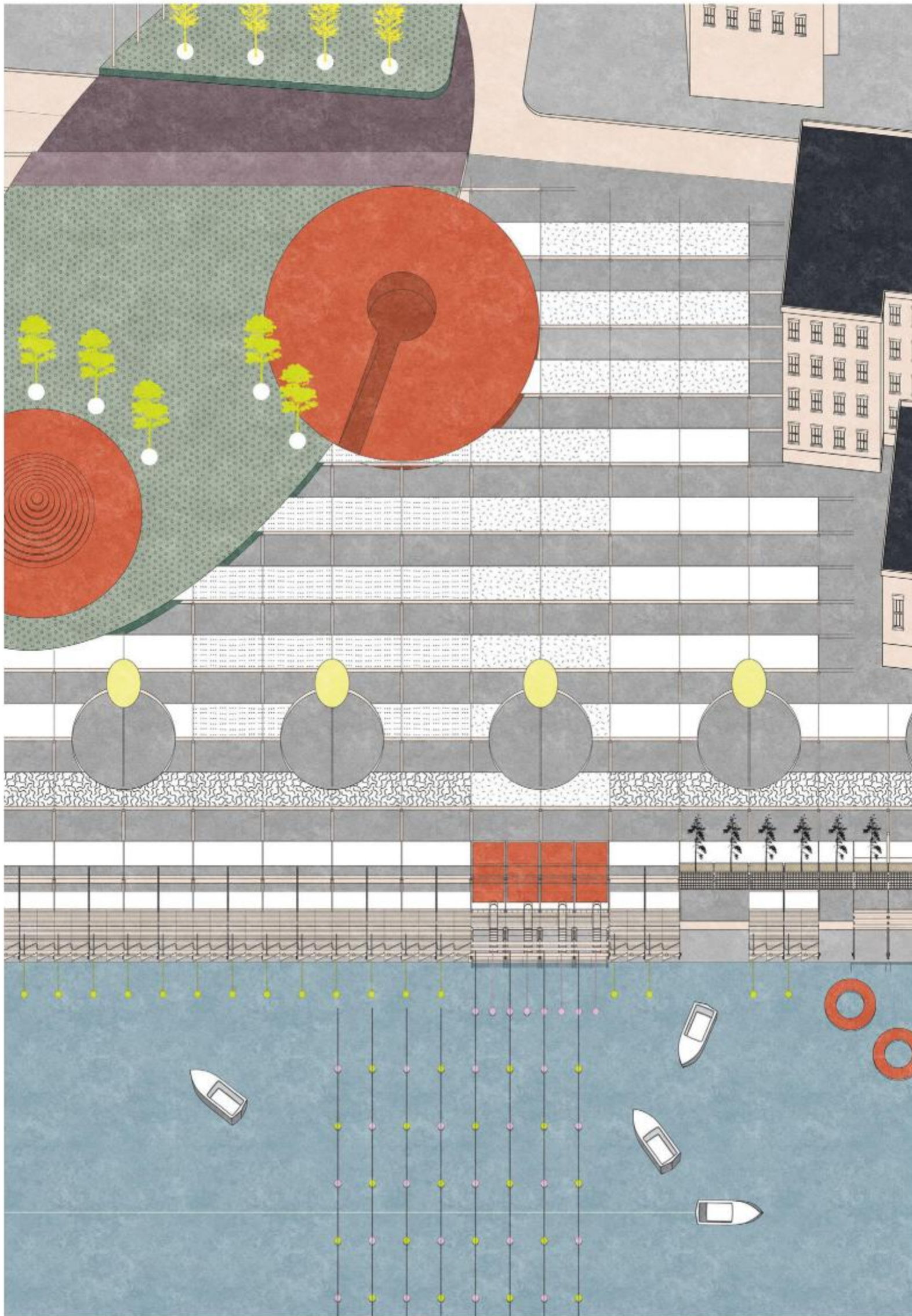

AN ADVERTISEMENT SPONSORED BY
HAVERTHILL, MASSACHUSETTS
MERRIMACK RIVER CITY

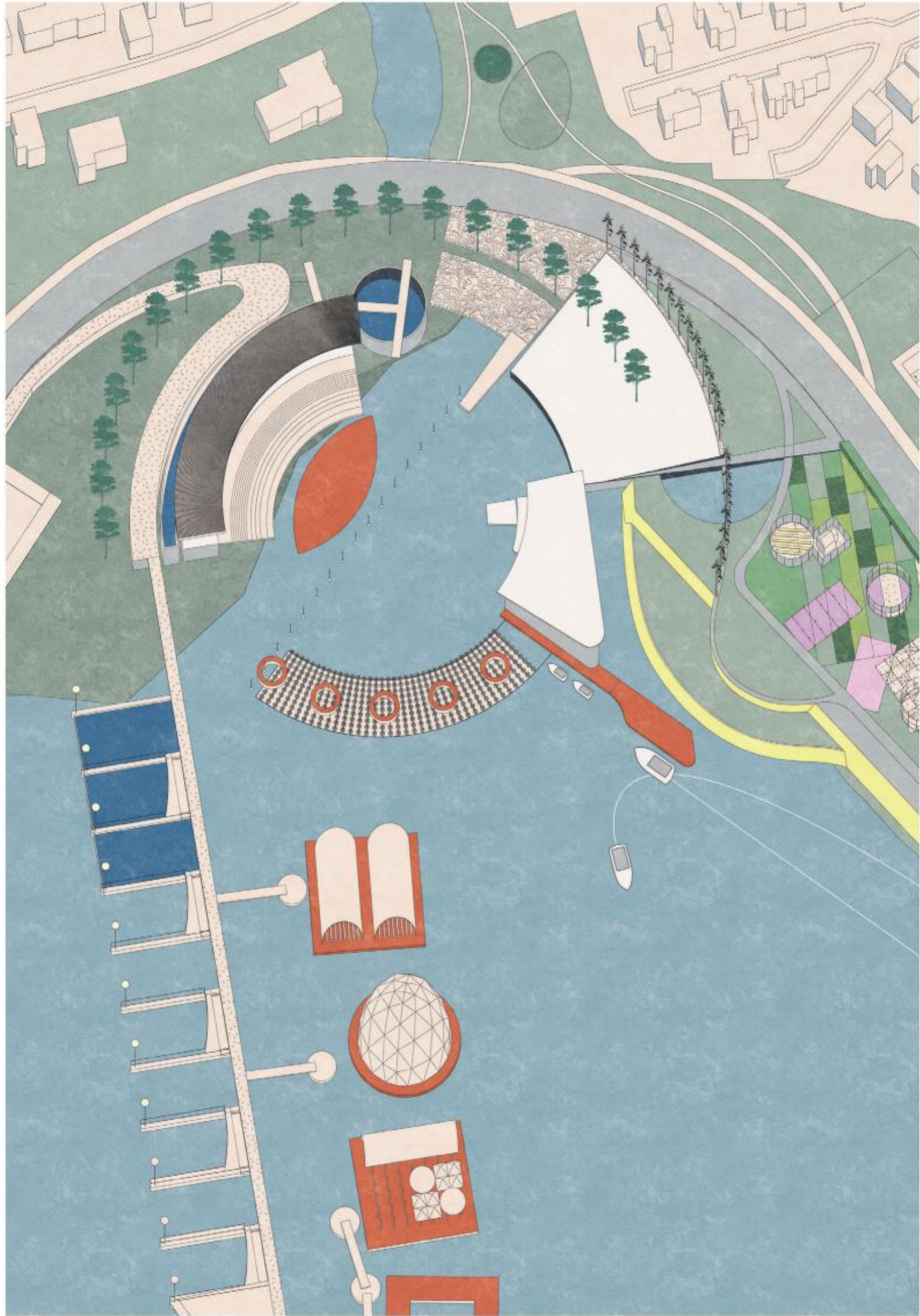

AN ADVERTISEMENT SPONSORED BY
LOWELL, MASSACHUSETTS
MERRIMACK RIVER CITY

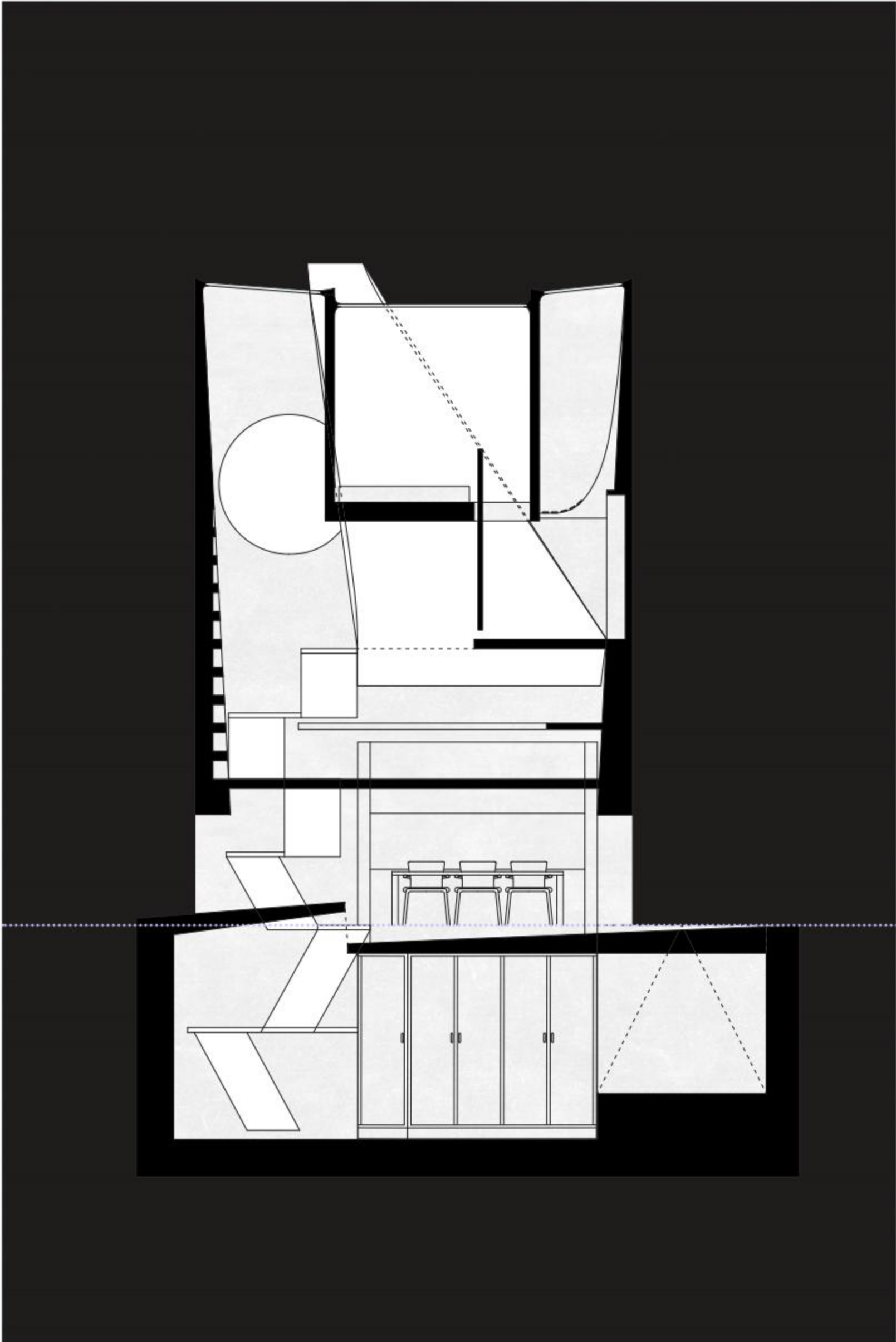

RITUALIZED INTERIOR

Yale School of Architecture

Spring 2017 Semester

The studio takes as its starting point the Chinati Foundation in Marfa, Texas. Founded by Donald Judd in 1979, the former Fort Russell campus was opened to the public in 1986 with the mission to preserve and present art in direct dialogue with the landscape.

The project seeks to interrogate Judd's work and original intentions through the design of the ritualized interior. Ultimately, a means to interrogate the territoriality of the rural interior, and an investigation into the relationship between the rituals of private life, the habits of production, and the demands of exhibition within artistic environs.

A set of spatial experiments preceded the building proposal; a set of interior rooms without an exterior form. The ritualized interior presents an opportunity to develop the intimate spaces of living independent of the external pressures of landscape and context. To translate this sentiment into built form results in a creation that approaches patterns of profound movement in the synchronization of recitation of daily rituals. The test of these new modes for dwelling is in their implementation on the sites within Marfa.

Judd's use of serial repetition helps to desubjectify his art. The multiple creates a system. In much the same way, each structure is of the same family, but each maintains a different character. The datum at the crest is consistent, but each structure meets the ground in highly specific ways. The scale of the studios changes where the ground changes. The spacing encourages metabolic rhythm, breathing, choreography.

Thomas Phifer with Kyle Dugdale, critics



Each artist is exhibited in a separate building on the 340-acre site, creating a campus of autonomous buildings, each with a specific relationship with the landscape. The foundation is unique in its treatment of art and its context as a permanent condition. By always positioning art within a landscape, the work is continuously defined by its surroundings: its scale, its expanse, its relationship to the sky and to the horizon, to the desert and to the terrain. This permanence between art and landscape is embedded in the territory of the town, creating a unique terrain in which work can be experienced as stable artifacts, “specific objects” un beholden to the increasingly market-driven world of art.

In Fort D. A. Russell, we find a bygone regime of power subsumed by art and landscape. We enjoy these landscapes because they mark the passage of power, the concealment and surveillance, and the residue of an empire. Here, we witness the dissolution of power. The preservationist has the delicate task of curating entropy, of manufacturing the picturesque. On the site, artists move vertically into their residences in order to experience the horizon from a new vantage, moving through layers of fortification. The monolith and the multiple create a system.





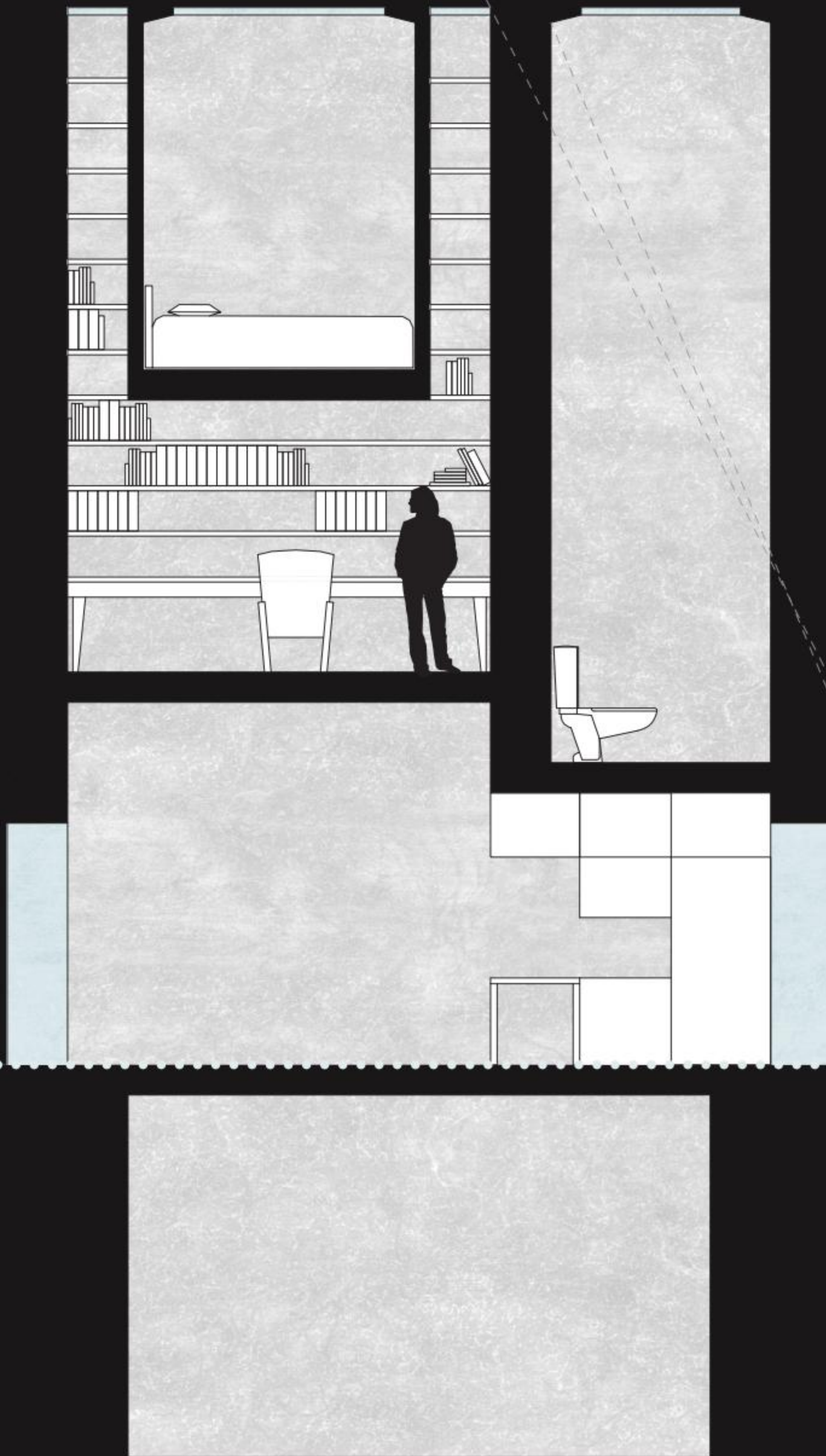

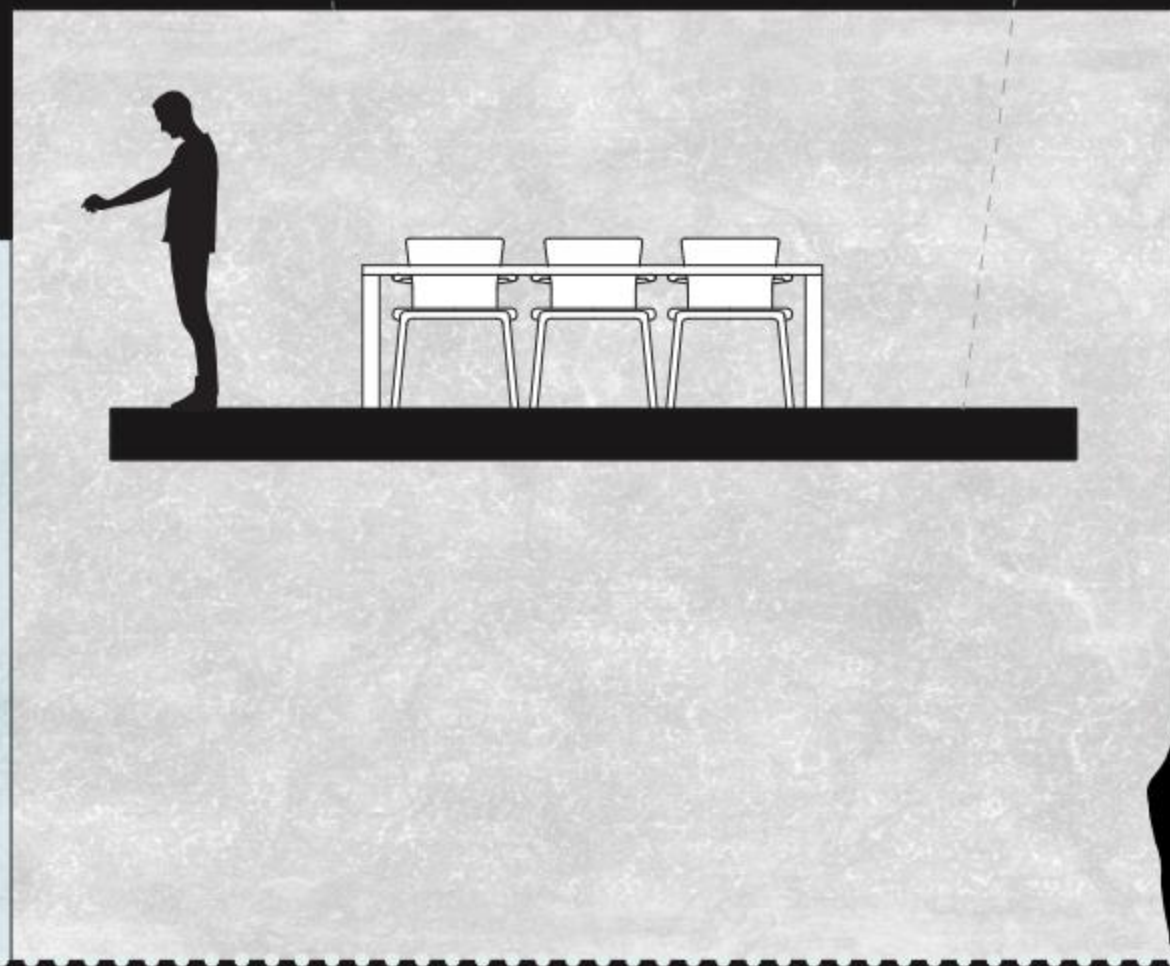
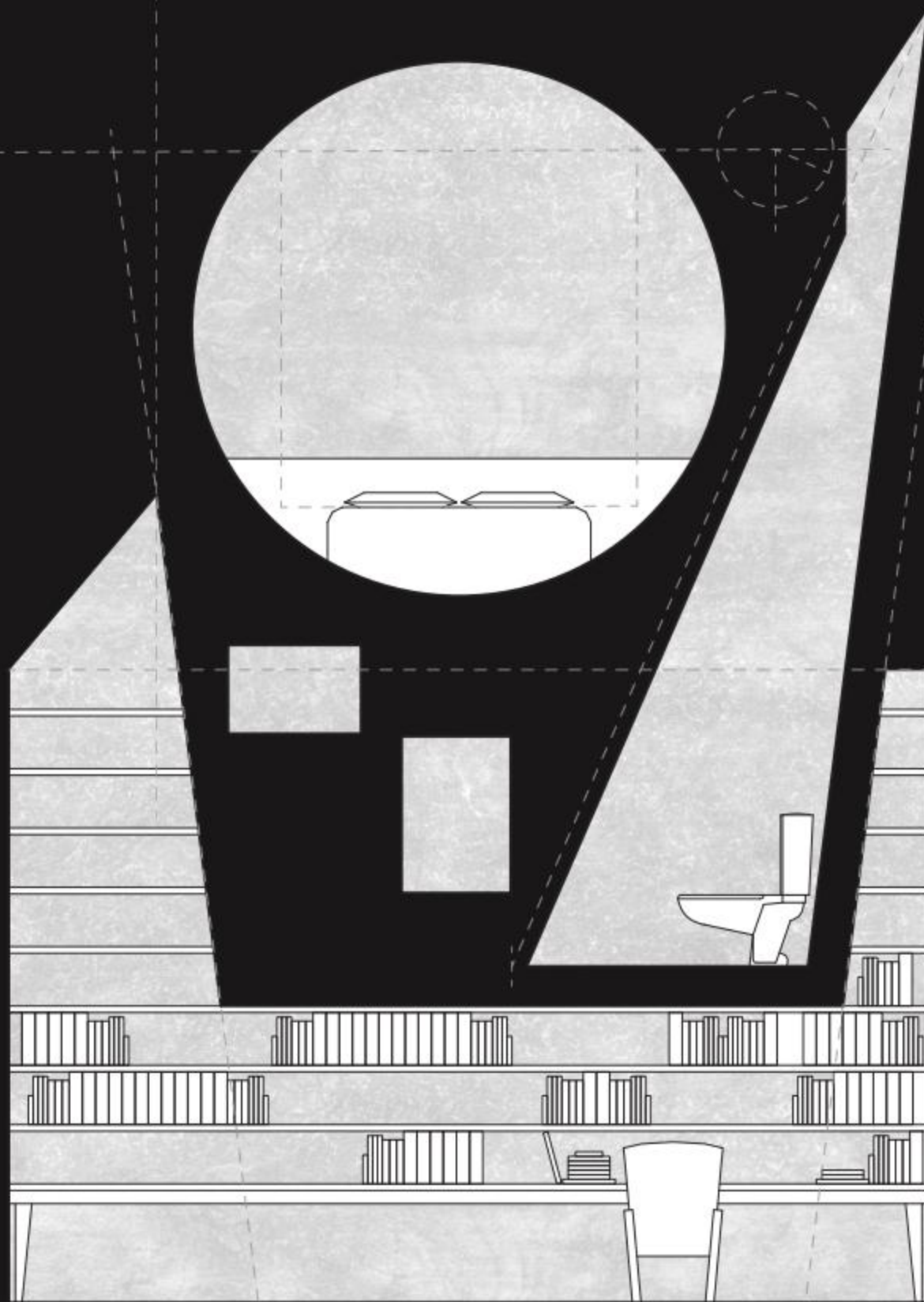

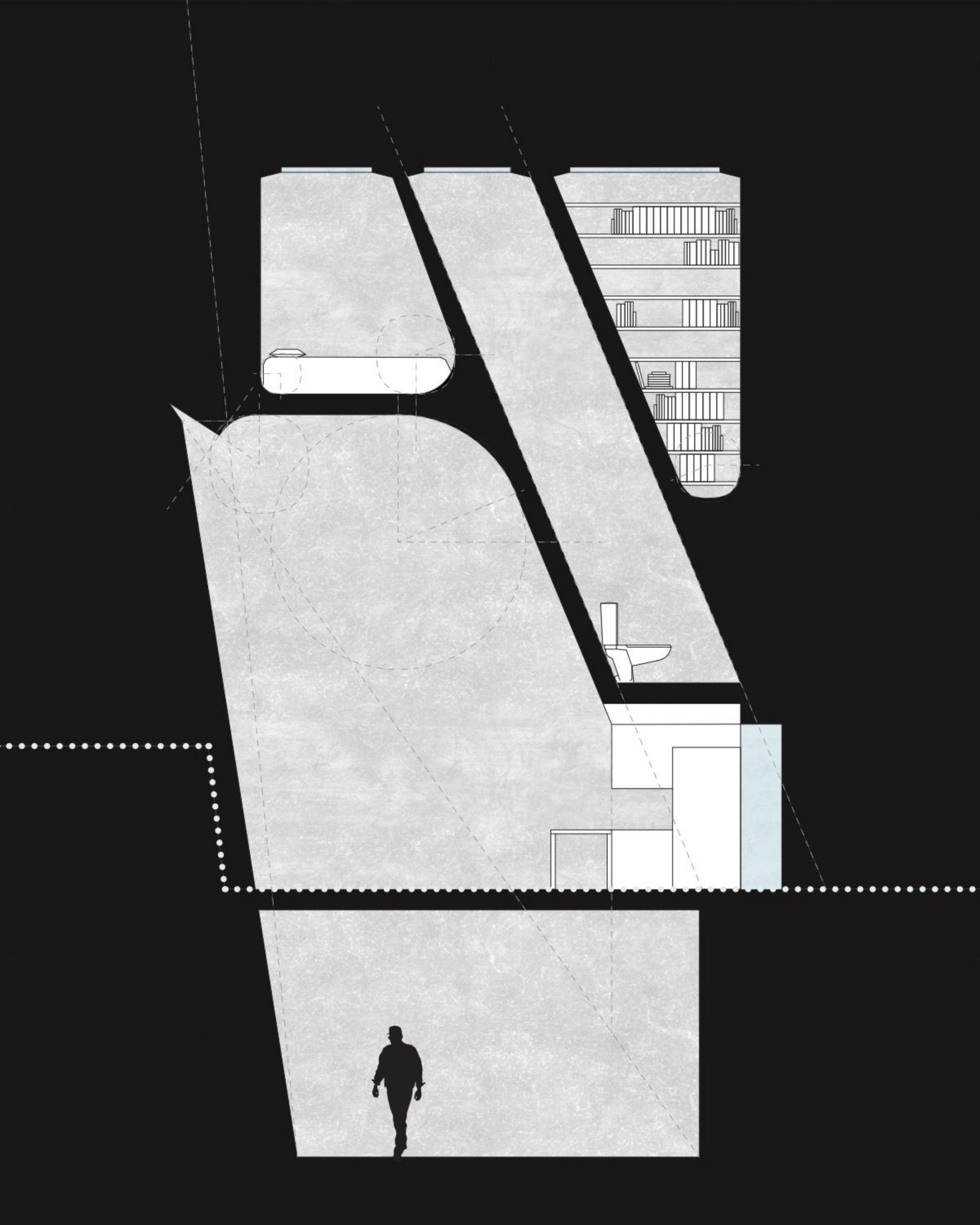

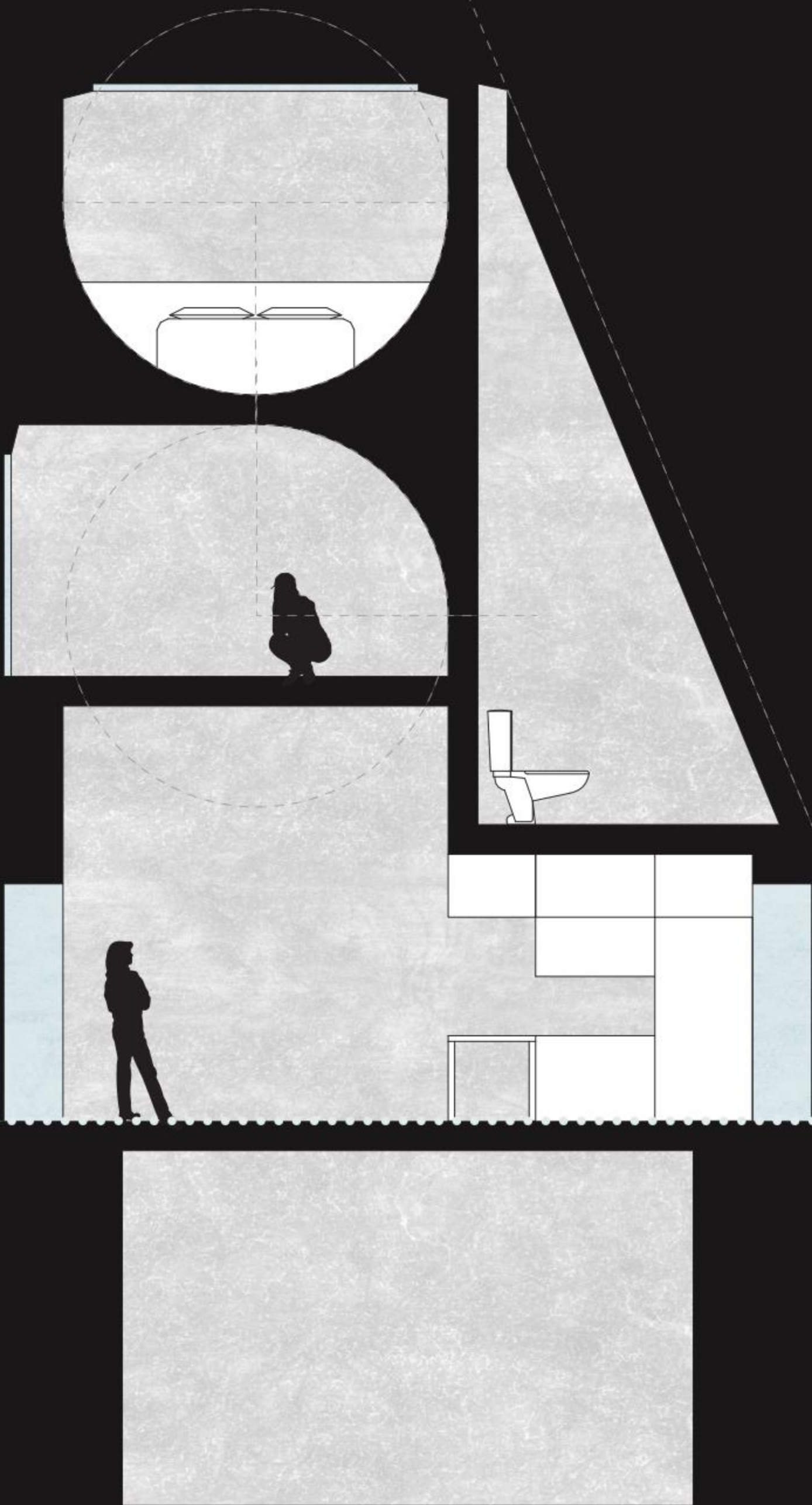

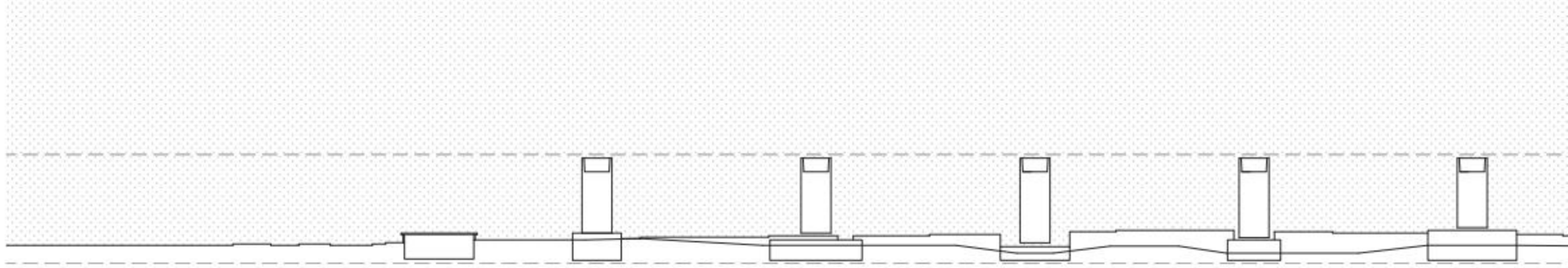
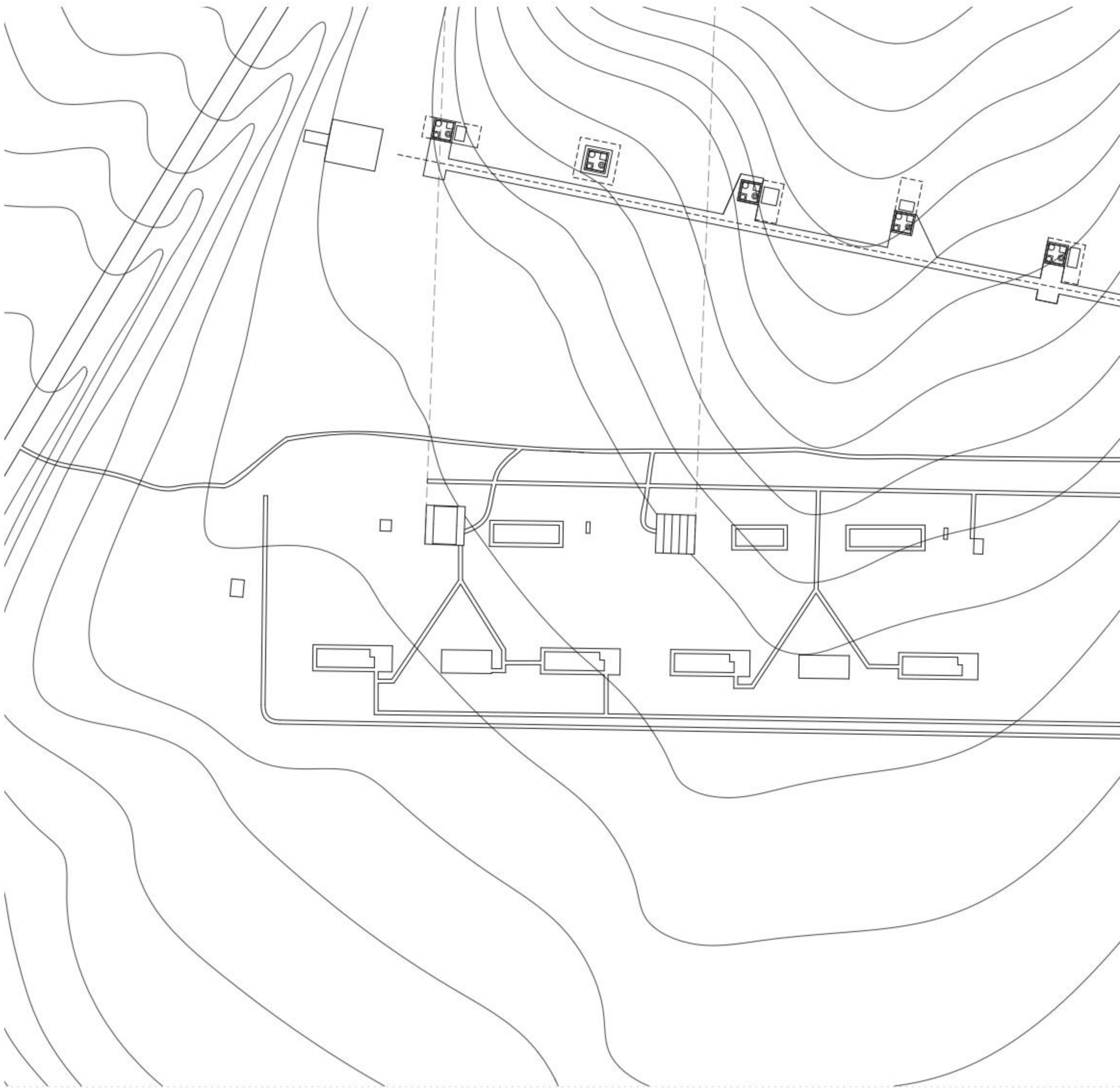

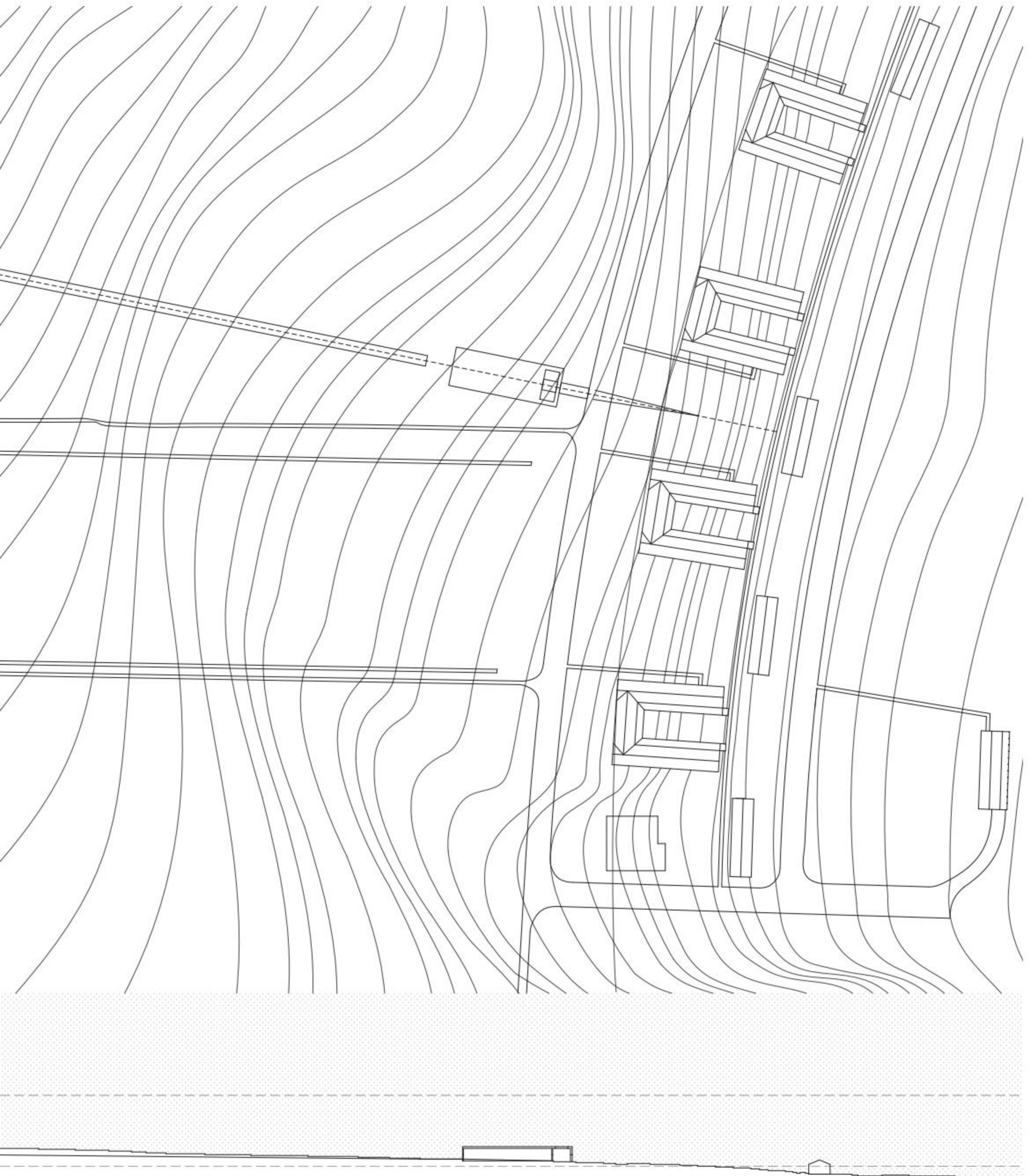

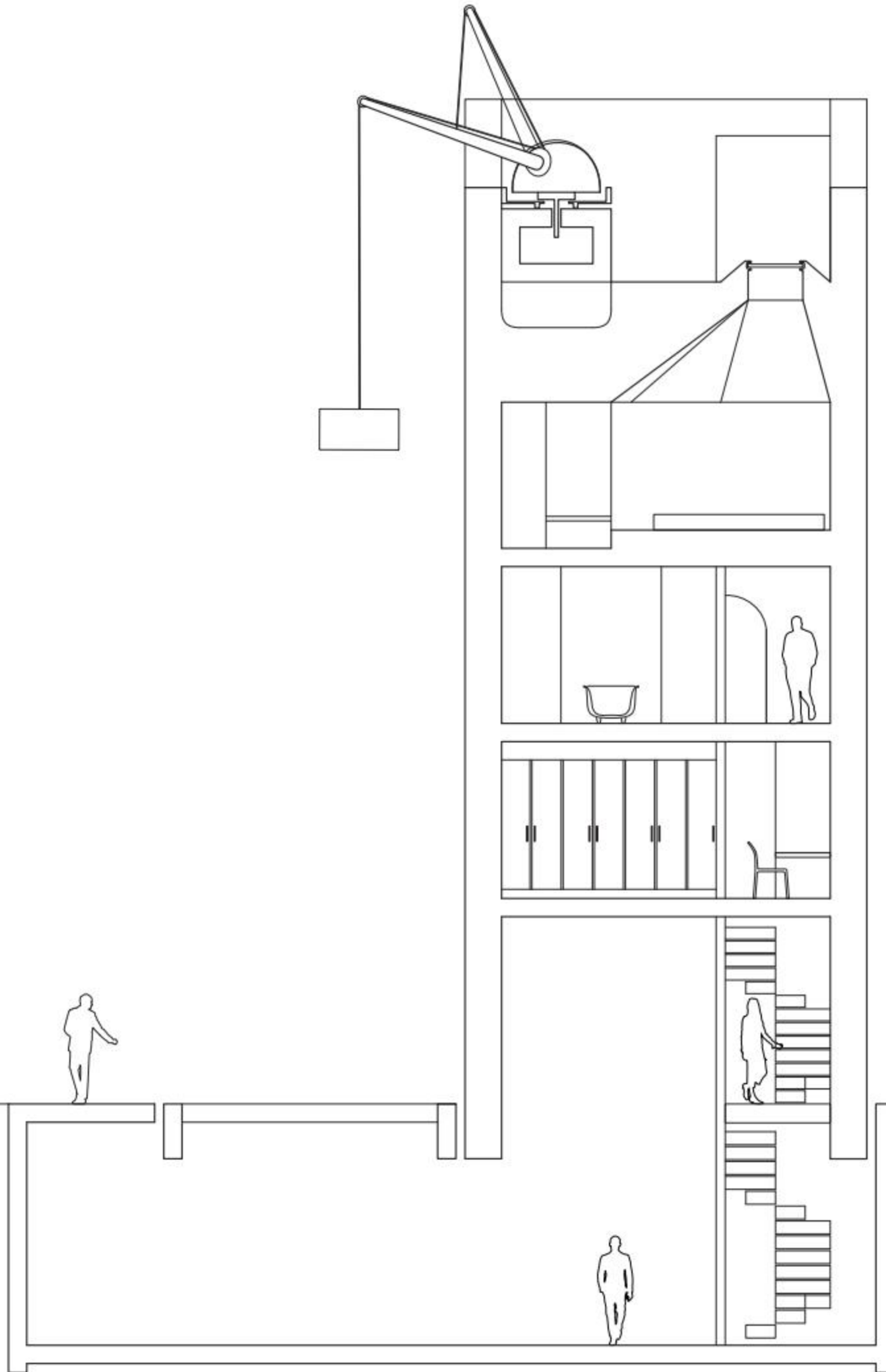

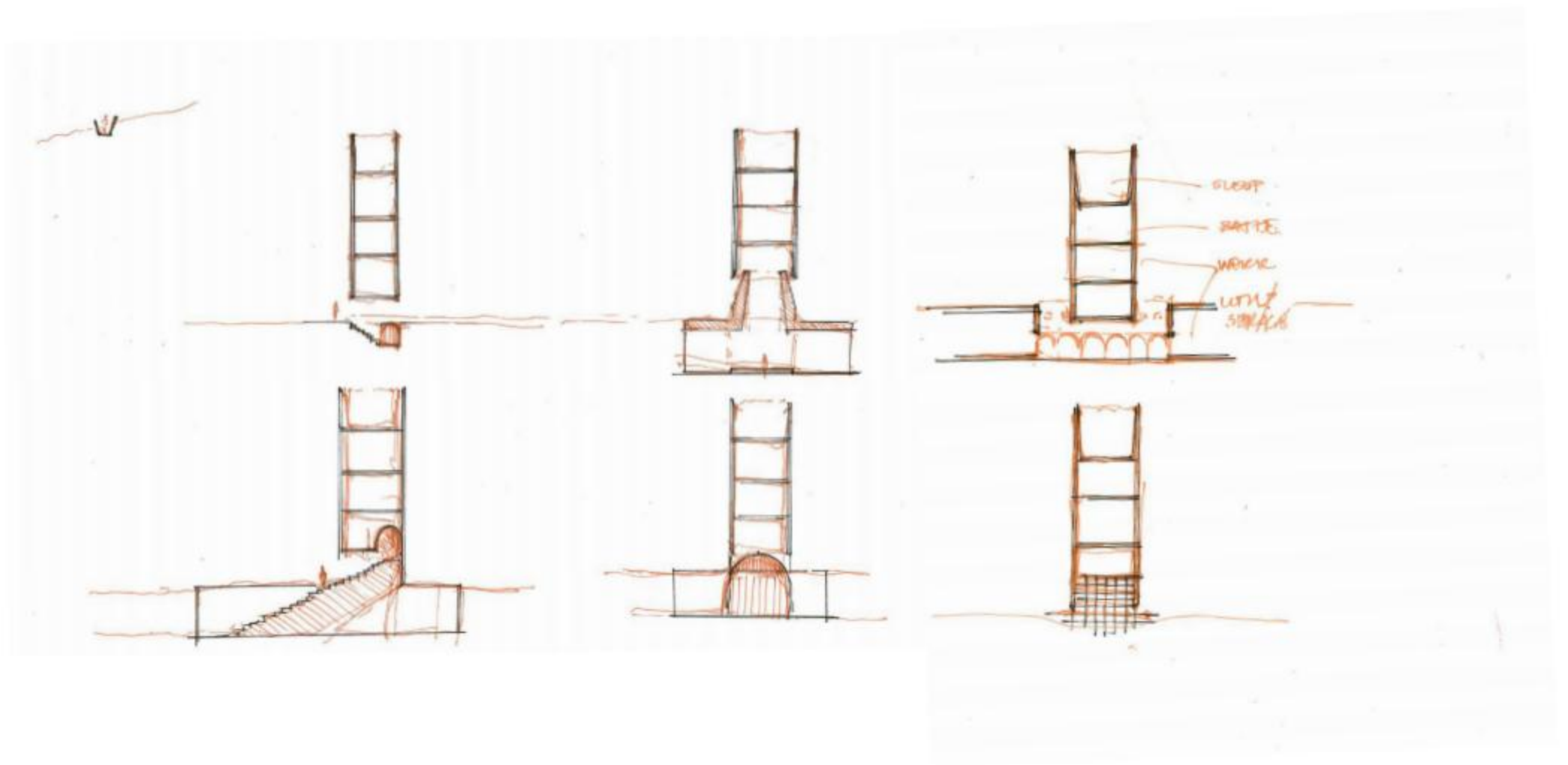

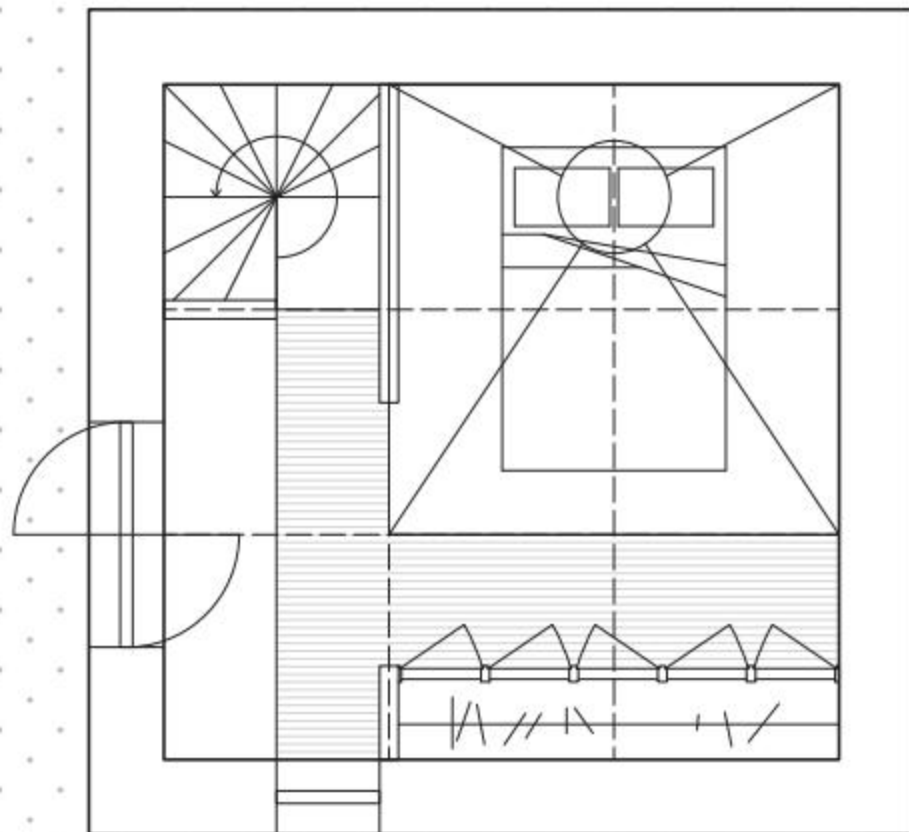
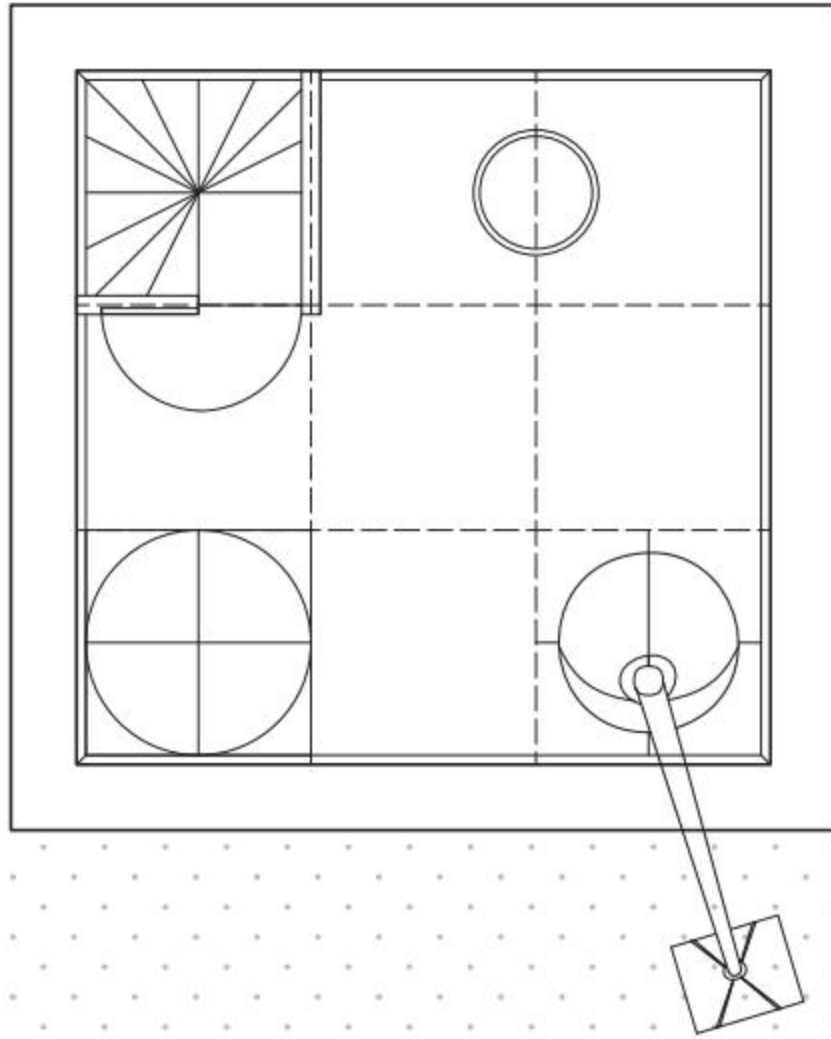

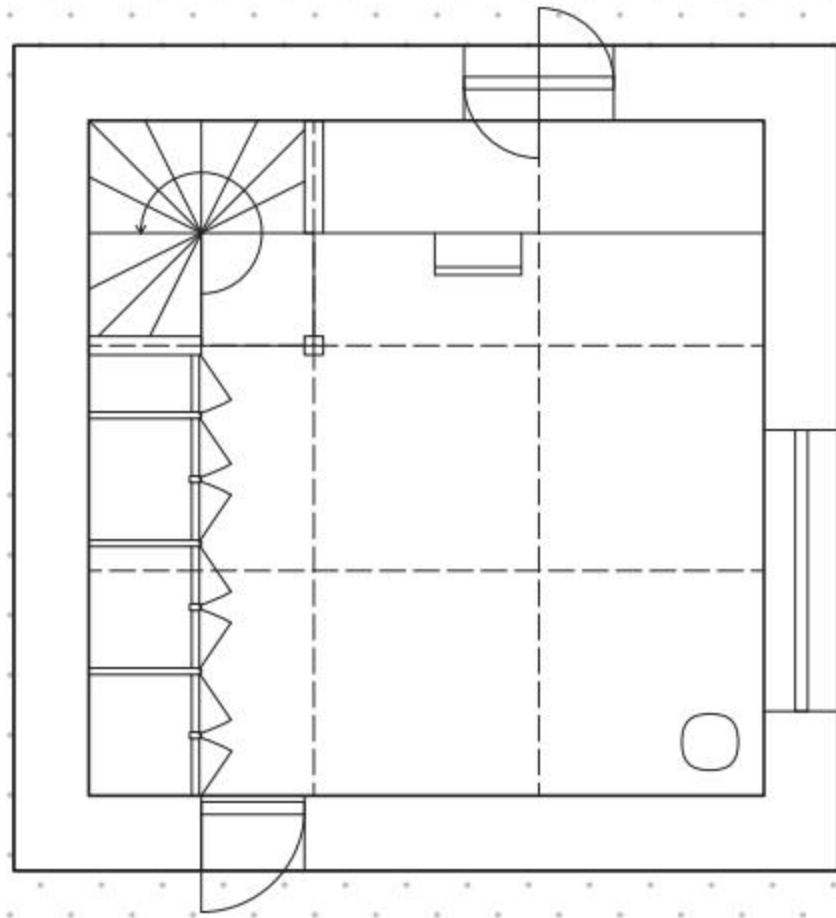
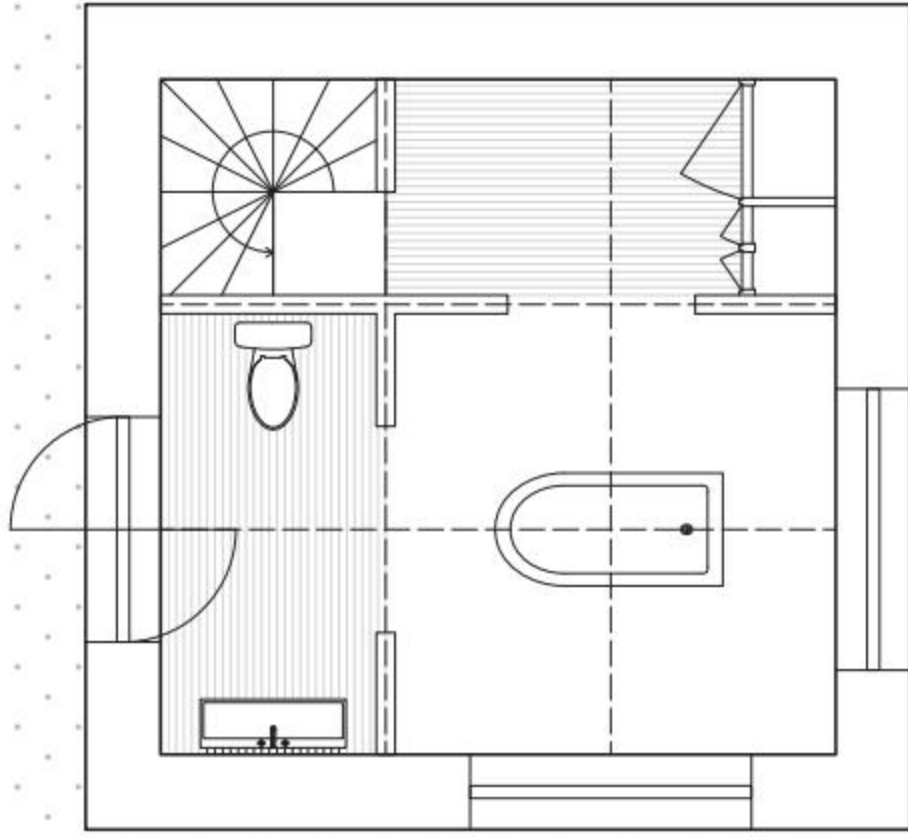





A SALVAGED SPACE

catered by the culinary arts

The City College of New York, CUNY

Spring 2012 Semester

Manhattanville is a hidden world of New York City, concealed under elevated train arches, and sheltered between the Hudson River and Harlem proper. Much of the neighborhood has seen an upswing in occupancy by food establishments: new restaurants and the Fairway market. The locus is appropriate for a school of culinary arts, and its construction would complete the site's identity as a food mecca.

An experiment in urban theory, we created a respectful yet innovative intervention under a strip of Manhattanville's infrastructure; a reclamation and celebration of old steel, offset by the introduction and liveliness of new steel. The dim area beneath the viaducts is brought to life with the infusion of our operation.

To understand the in situ, we composed a taxonomy of site context and program attributes that assigned architectonic moves to inform the volumetric rhythm and composition of the project. In occupying the area underneath the viaducts, a modular was crafted and delineated by the two existing column grids. The system allowed for individualization of program and a symbiotic relationship between each volume. Based on the framework of the taxonomy, each component allowed the modular to break, expand, contract, and sculpt itself for optimal use (light, ventilation, storage, movement). The result is a site-specific response that respects the existing infrastructure as artifacts. Circulation is residual space; an interplay of solid and void.

Program:

Teaching Kitchens: 1,250 sf each
Pastry Kitchen: 1,250 sf
Classrooms: 450 sf each
Demonstration Lab: 900 sf
Lecture Hall: 1,500 sf
Library: 1,800 sf
Student Lounge: 450 sf
Bake Shop: 600sf
Restaurant: 3,000 sf
Receiving Area: 900 sf
Trash Area: 300 sf
Administrative Offices: 1,700 sf

Total Program: 21,250 net sf
Total Building Area: +/- 27,625 sf

Artur Dabrowski, collaborator

Fabian Llonch, critic

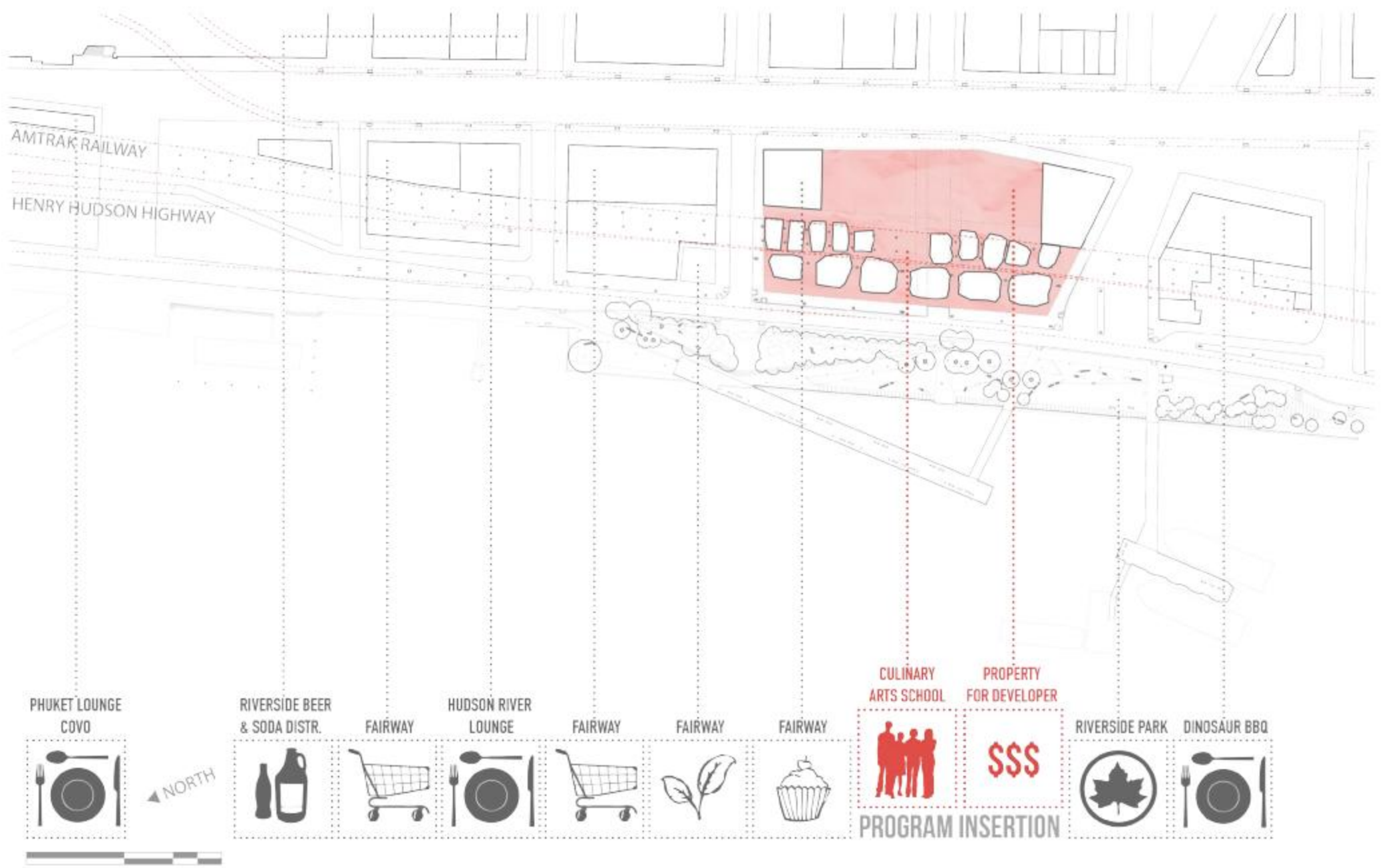

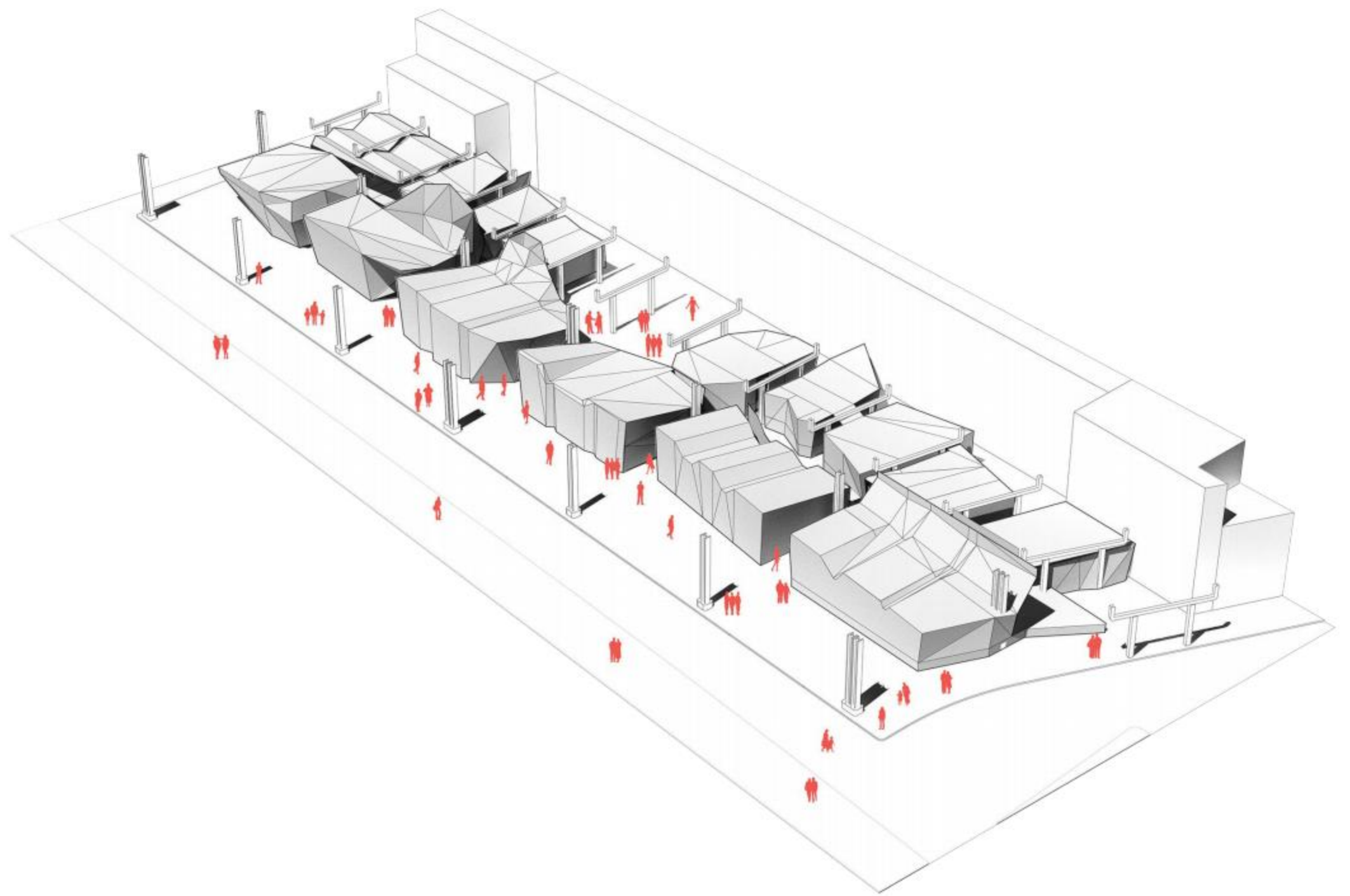

I EXISTING STEEL

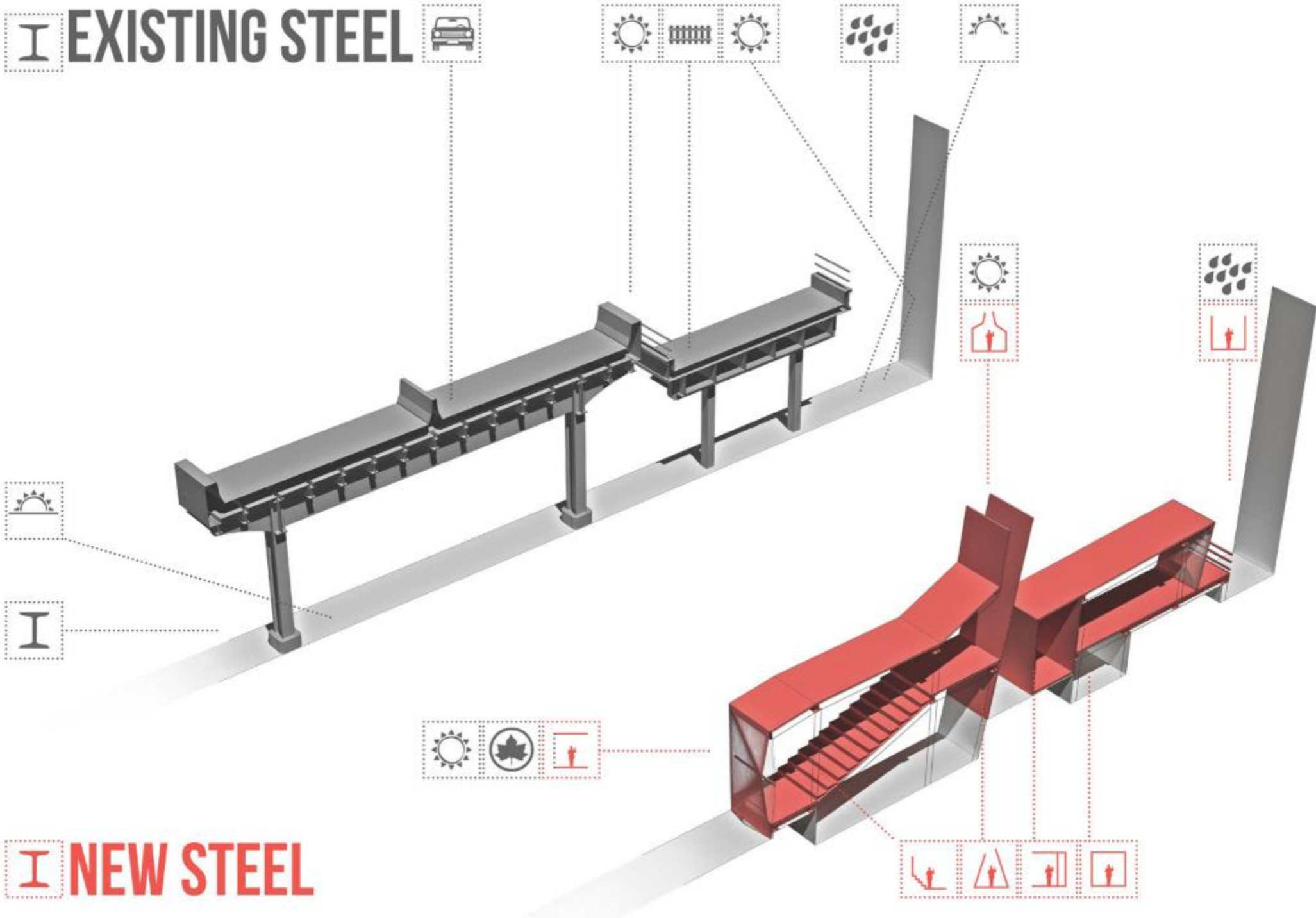

I NEW STEEL

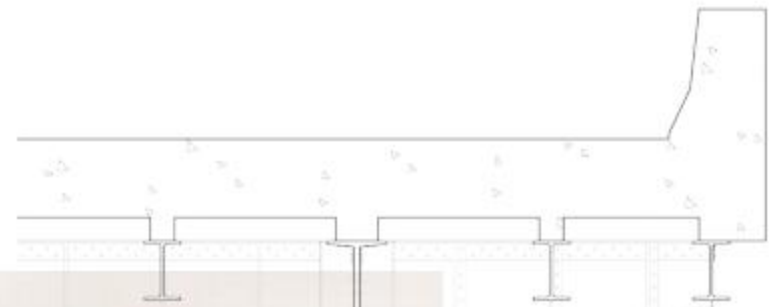

EXISTING STEEL STRUCTURE,
RIVETTED BOLTED MEMBERS
SUPPORTING CONCR ABOVE

HVAC OVERHEAD EQUIPMENT
STL I BEAM CEILING JOIST
FIREPROOF COAT PTD WHITE

CORRUGATED STL
CEILING, PTD WHITE
ACOUSTIC SOUNDPROOFING

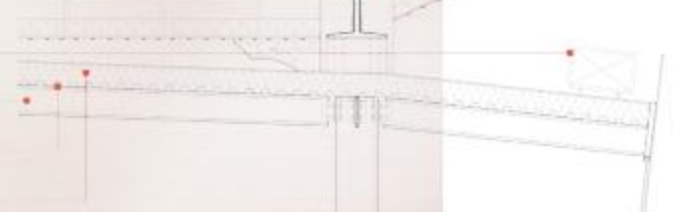

1/4" PERFORATED STL
MESH, PTD WHITE

3/4" DOUBLE PANE GLASS
W/ STL MULLION PTD WHITE



STL I BEAM STRUCTURAL
COLUMN CORE

QUARRY TILE FLOOR

CORRUGATED STL TO
ACCEPT 2" CONCR POUR

STL I BEAM FLOOR JOISTS

REINFORCED CONCR
SHALLOW SLAB FOUNDATION

OPERABLE PANEL TO ACCEPT
HVAC AND PLUMBING,
FILTERS AIR INTO SPACE

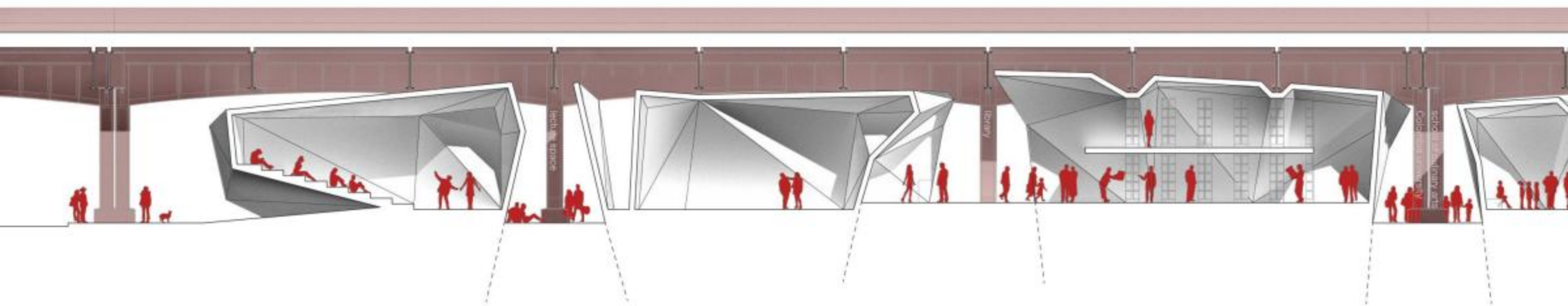
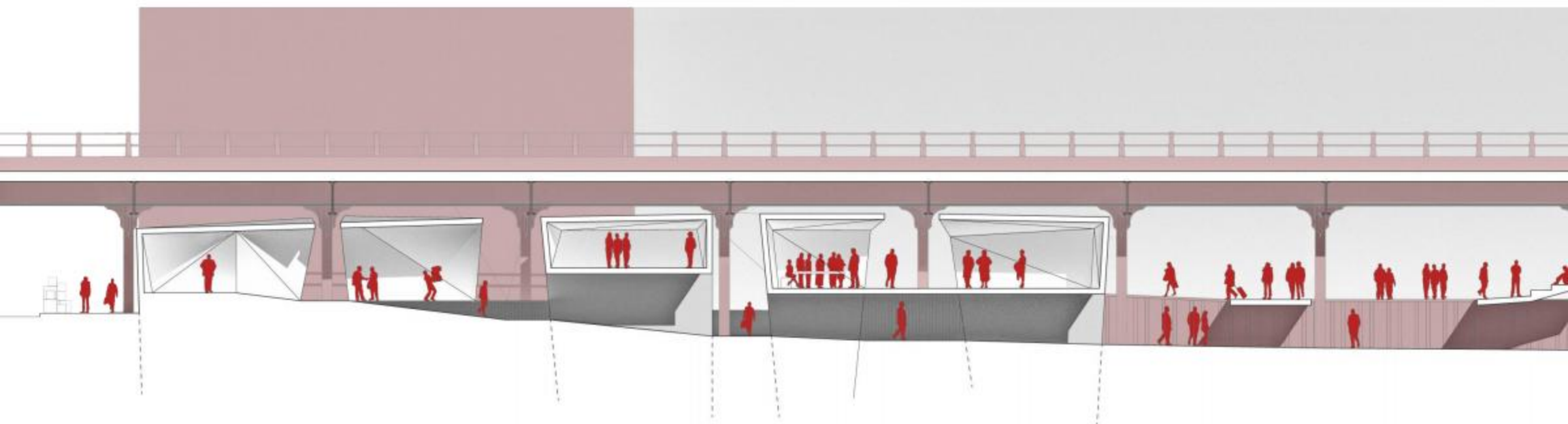

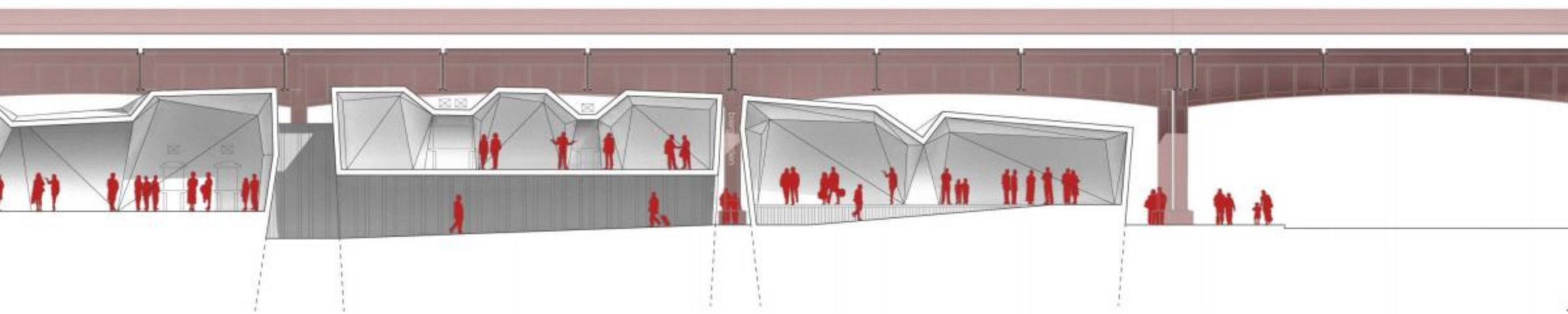
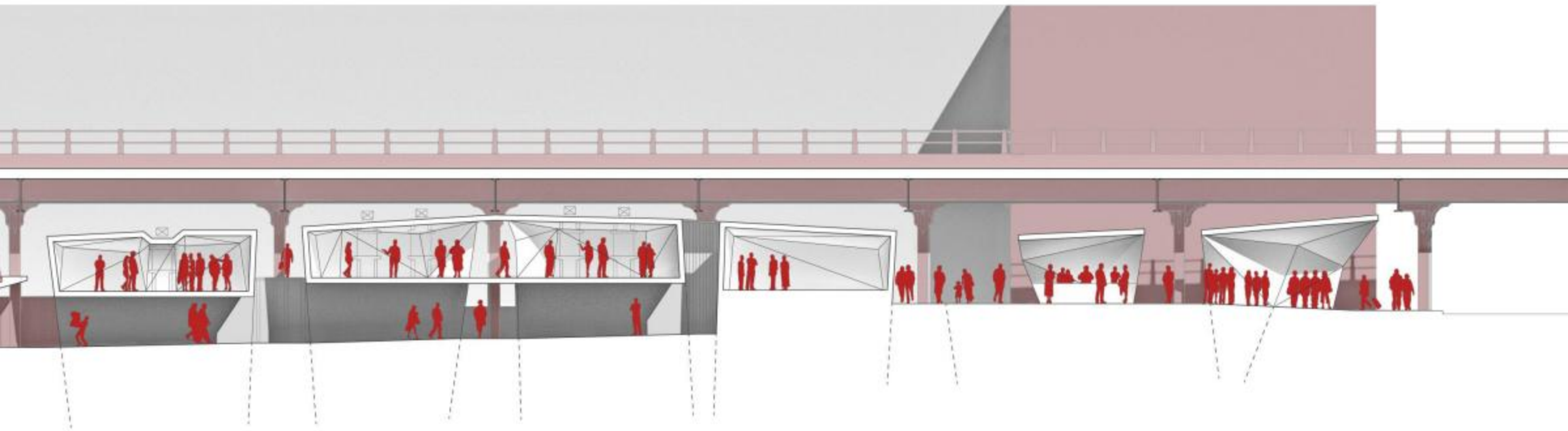

FORMAL ANALYSIS

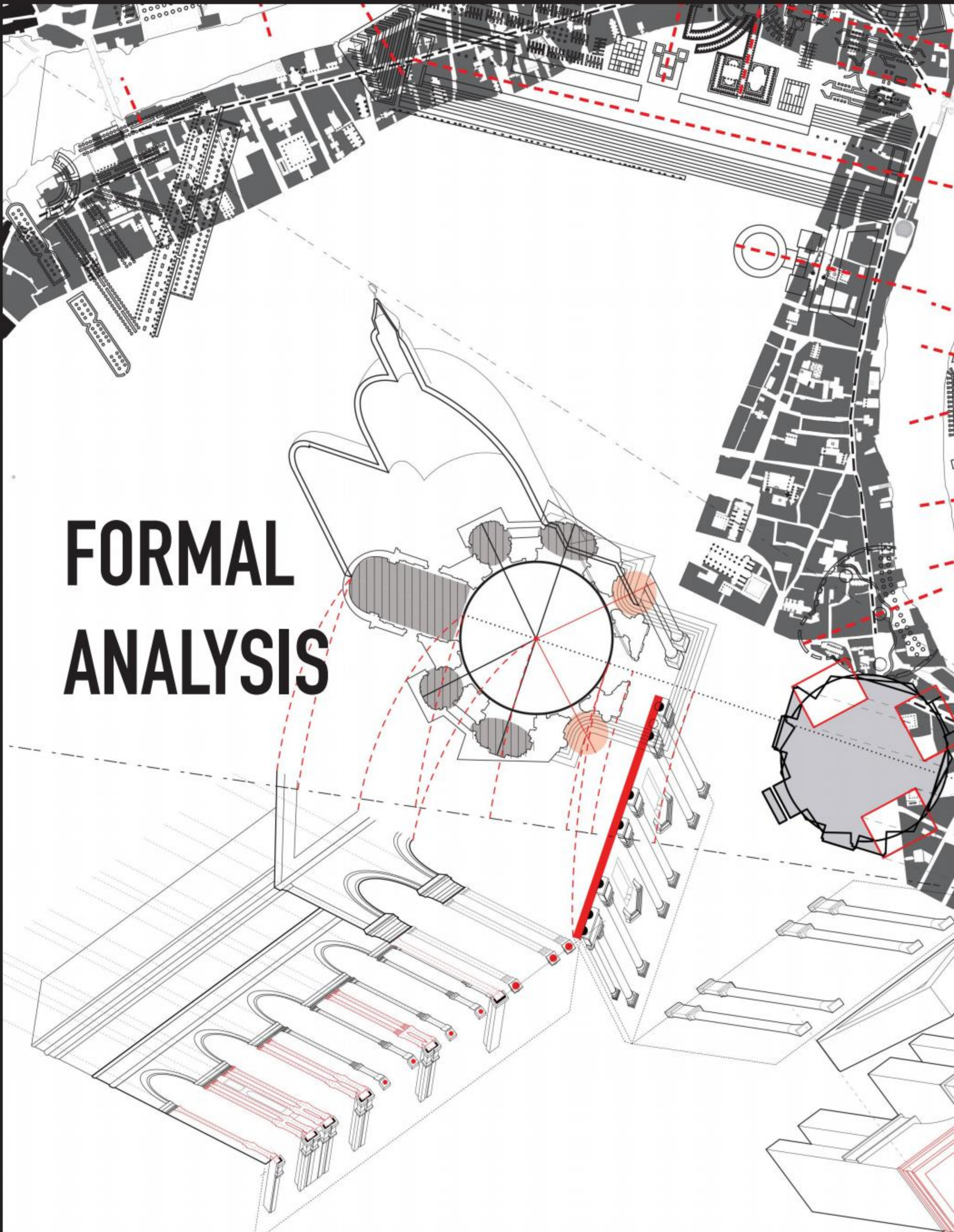

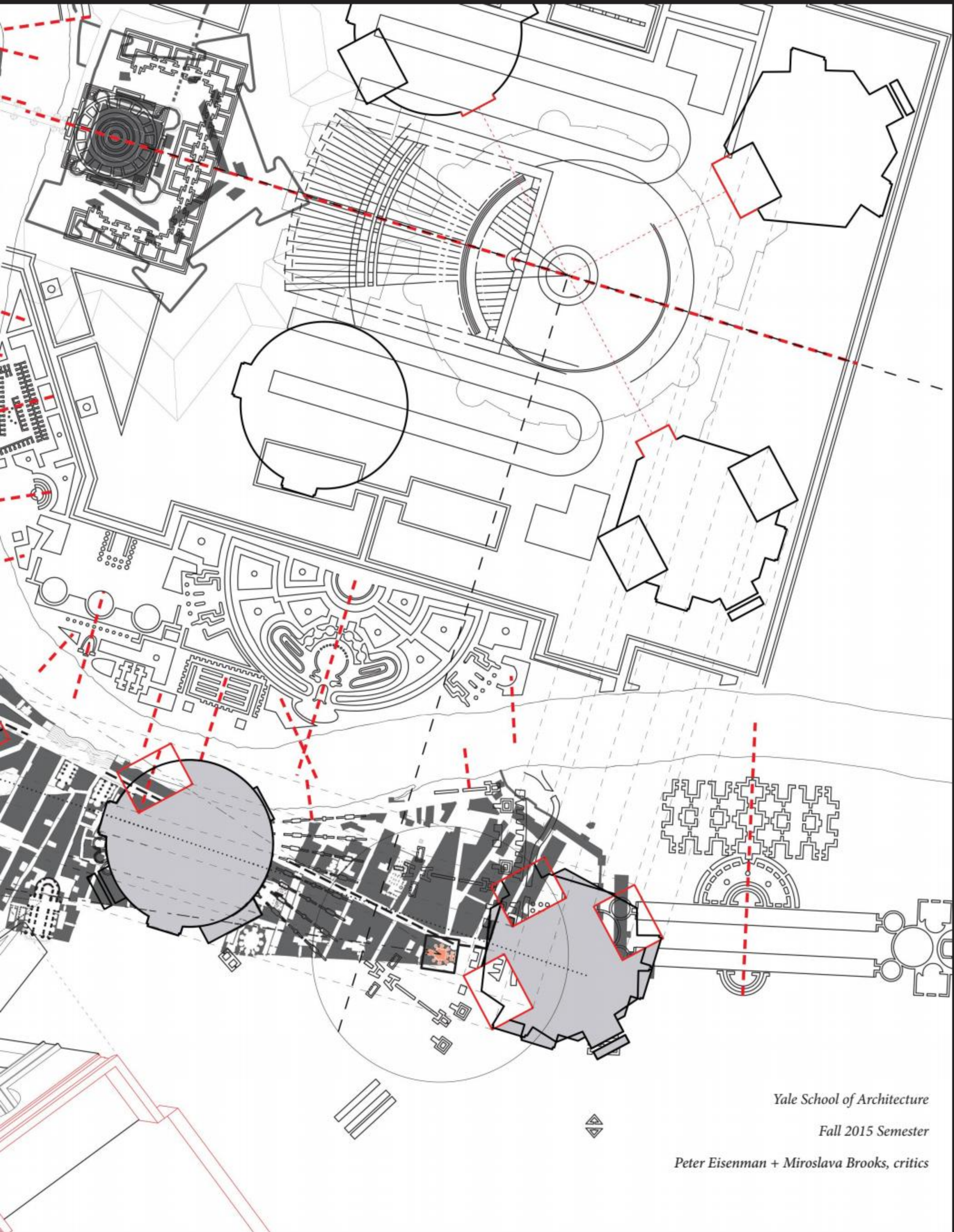

Yale School of Architecture

Fall 2015 Semester

Peter Eisenman + Miroslava Brooks, critics

Serlio — A First Critique of Homogenous Space

We often ascribe the works of Bramante to the culmination of understanding and expression in the relationship of part to whole. Appropriately, we look to Serlio's Mannerist designs for the subversion of those relationship ideas. With his use of figural poche, Serlio explores methods of tension and compression in plan. His forms imply directionality, pushing out on the diagonal and enabling circulation on the orthogonal axes. With a main central space in perpetuum, we can begin to experience both centripetal and centrifugal forces at play. We see the same figures depicted in different scales as a further disruption of earlier part to whole ideals.

The drawing explores Serlio's Pavilion for a King titled 'On the Small Royal House Outside Cities.' Geometric characters seem to float within a field of thick poche atop an informal nine-square grid. The drawing examines the spaces of the camera forms that flank the palazzo and the augmentation of their local symmetries. Three out of four cameras are hexagonal in shape, contain a fireplace, and have a direct relationship to the center. The fourth camera is a bath, a circular space in isolation from the rest. By literally folding the plan across two axes, we start to uncover relationships between these nodes. Similar patterns occur at increasingly smaller scales, as Serlio's palazzo performs as a fractal to the larger plan.

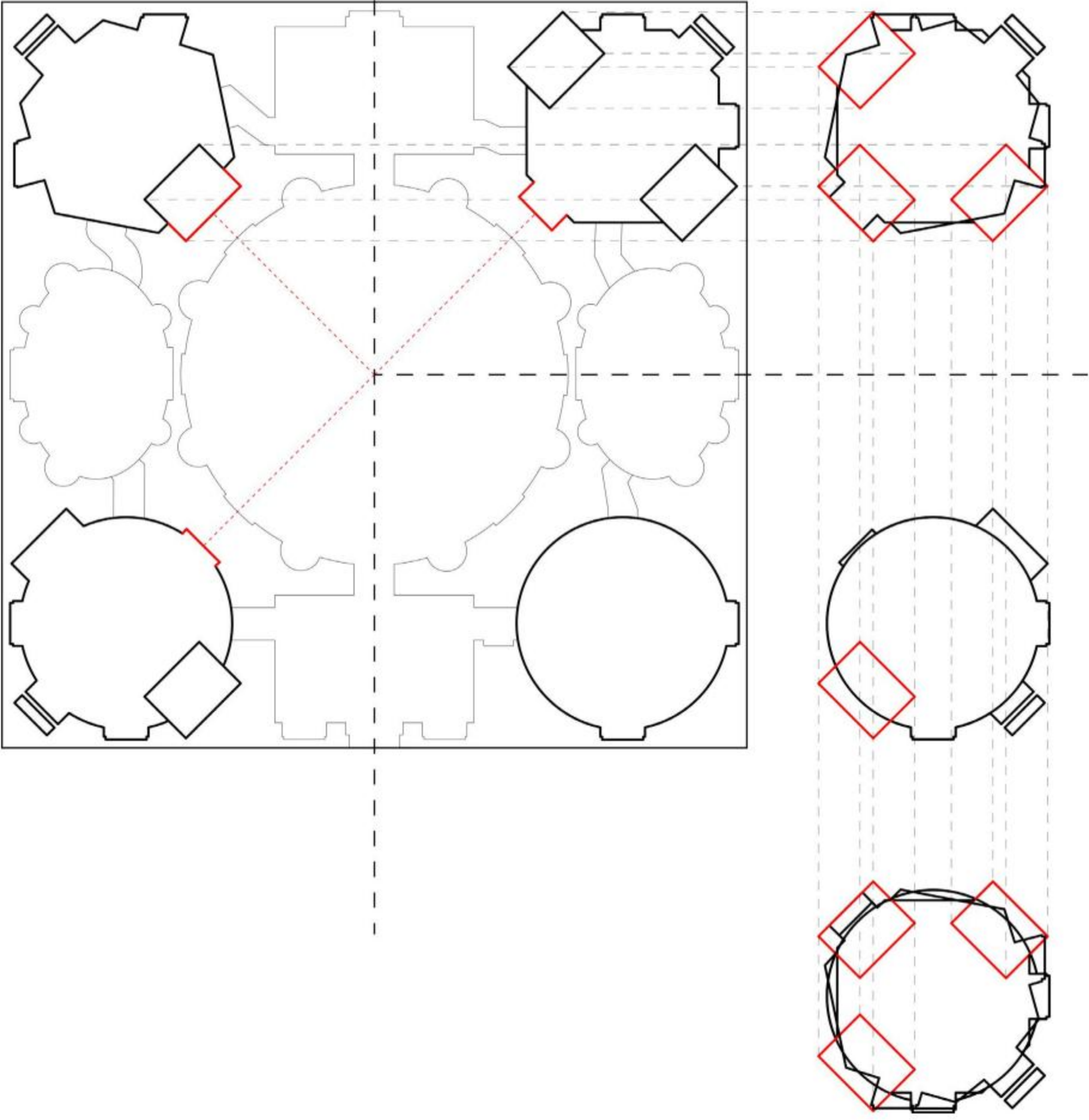

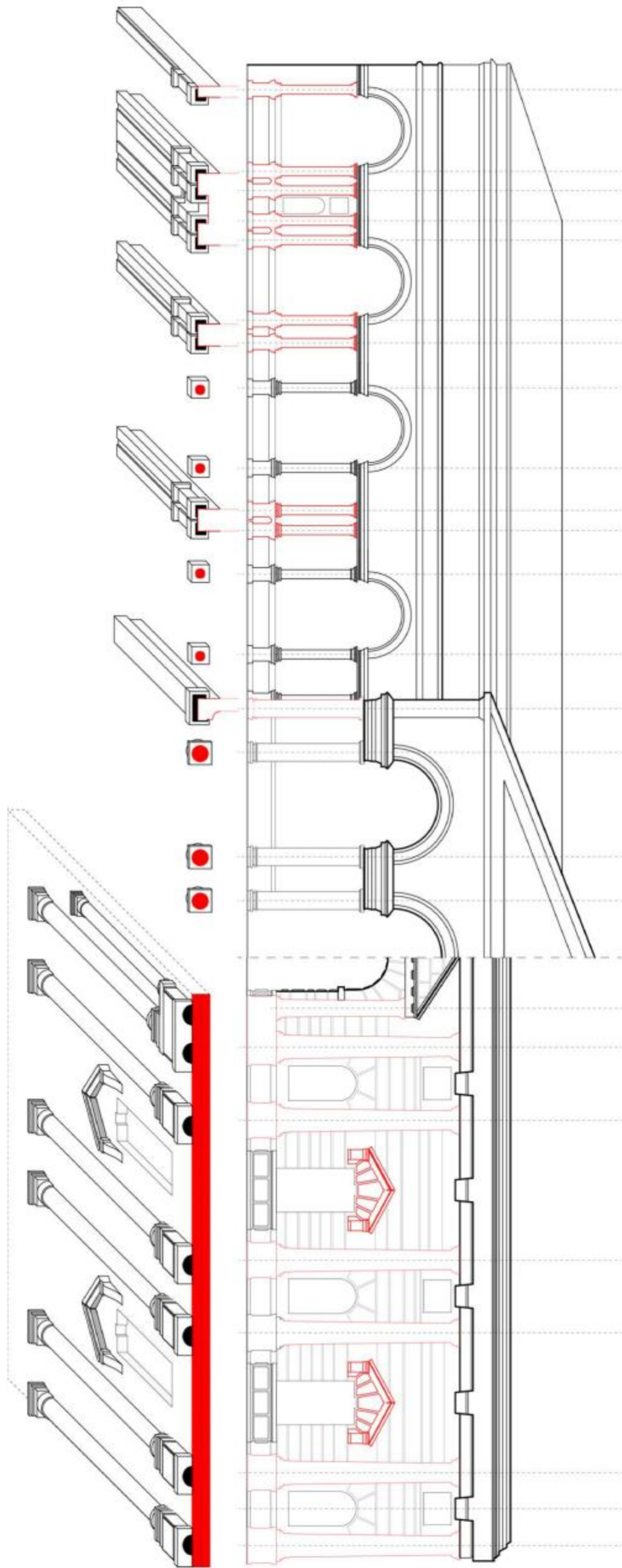

Giulio Romano — Palazzo del Te

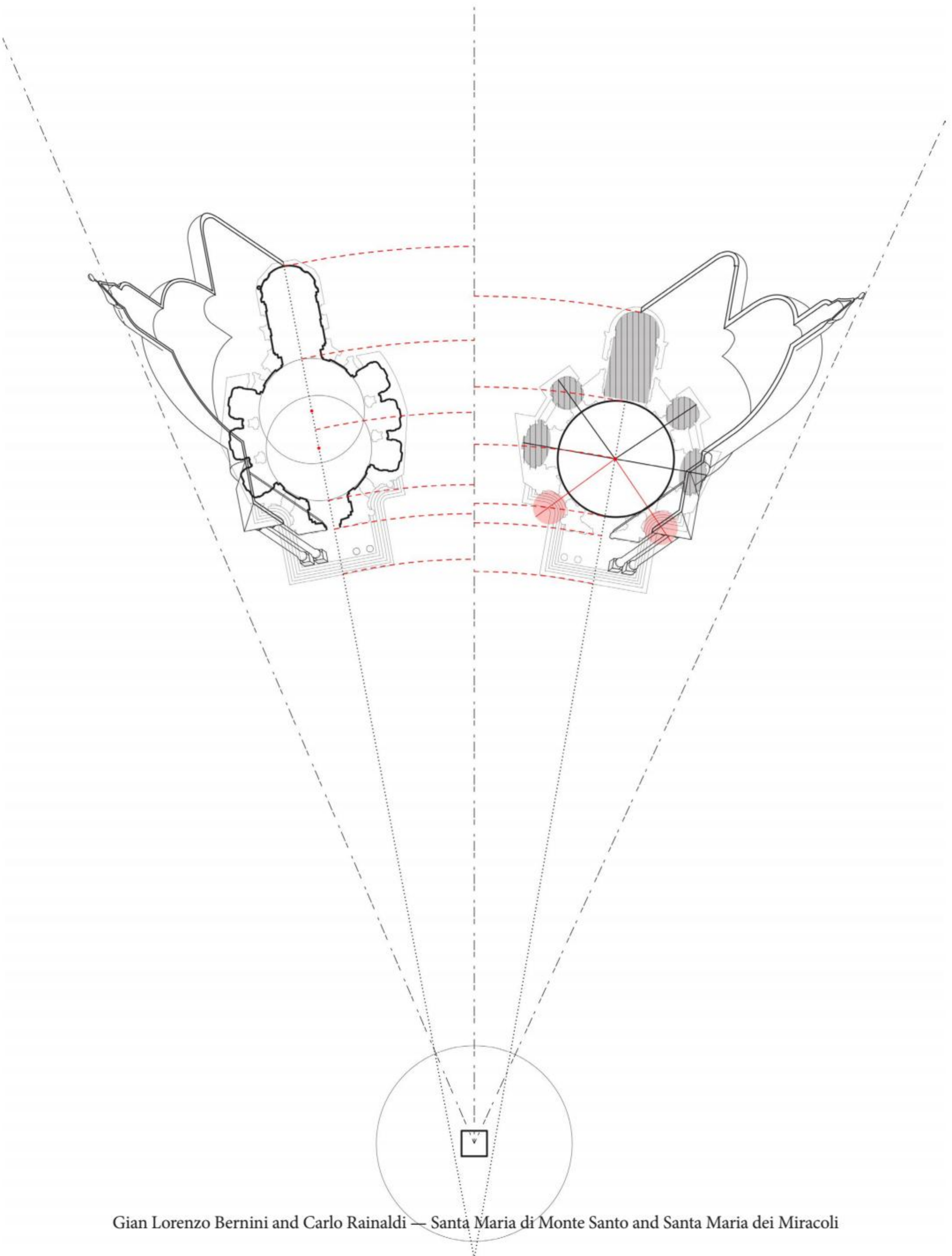

Gian Lorenzo Bernini and Carlo Rainaldi — Santa Maria di Monte Santo and Santa Maria dei Miracoli



SUGAR HILL CAFE

Design Competition Winner

410 W 145th Street. New York, NY 10031

Winter 2014

The project called for the design of a cafe for a locally based coffee shop in the Hamilton Heights section of Manhattan. A competition was held for students and alumni of the Spitzer School of Architecture at CCNY, located just a few blocks south of the site.

The cafe is located on a great street with lots of activity, but the elevation is adverse. As a business occupying the basement level of an attached apartment building, visibility is key. Although 'underground' has hip connotations, we wanted to avoid creating a dingy basement aesthetic. A bright environment disassociates the idea of going into a basement. We paired bright bursts of color with the neutral colors of the brand logo

Red seen through the window breaks from the continuity of the street above. The band descends from the shelves and column to a piece of millwork that formally looks old and aged. The red color will give a fresh new life to the artifact, as we use local Sugar Hill history to foster a new culture and a new business.

Mint as a secondary color adds highlights and luminosity to the space without competing for attention with the red. The objective is for a more meaningful integration of context, history, identity, and coffee.

Artur Dabrowski, collaborator



Cream Brown Dark Grey

The three colors of the logo manifest as the colors of the cafe space. These colors establish a familiarity between the brand and space.

Brand Recognition

+

Space Recognition



Red Mint

The three neutral colors of the brand are introduced to a new pair of colors that define the architecture of the cafe space. These colors bring contrast in order to highlight the function of the space.

Why Red? Color theory supports the idea that the color red is the most activating, stimulating, passionate, exciting, powerful, and expanding color. Visible from tiny window, it draws attention and is excites people to buy. Red will be the primary color of the space.

Mint green will be the secondary color. It is used to highlight spaces likes storage and display, but not overwhelm the customer and not to disquiet their attention from what is for sale. Green is a calming, harmonious, and rejuvenating color. It is, in many ways, the balancing element to red, our primary color that contrasts the brand.

Red = Purchase, stock display, goods for sale
Mint green = storage, display

Palette of Textures



Existing Joists Wood Ceiling Countertops
Main Counter Subway Tile Chickenwire

The Red

This single band of color is an aesthetic device that simultaneously achieves:

- an envelope around the service area, highlighting the barista and cashiers
- a visual attraction from the street, contrasting with existing fabric and not conflicting for landmark approval
- adds volume of storage and display

Cream eggshell painted walls fill the majority of the space. The color lightens the space and adds a subtle sepia atmosphere.

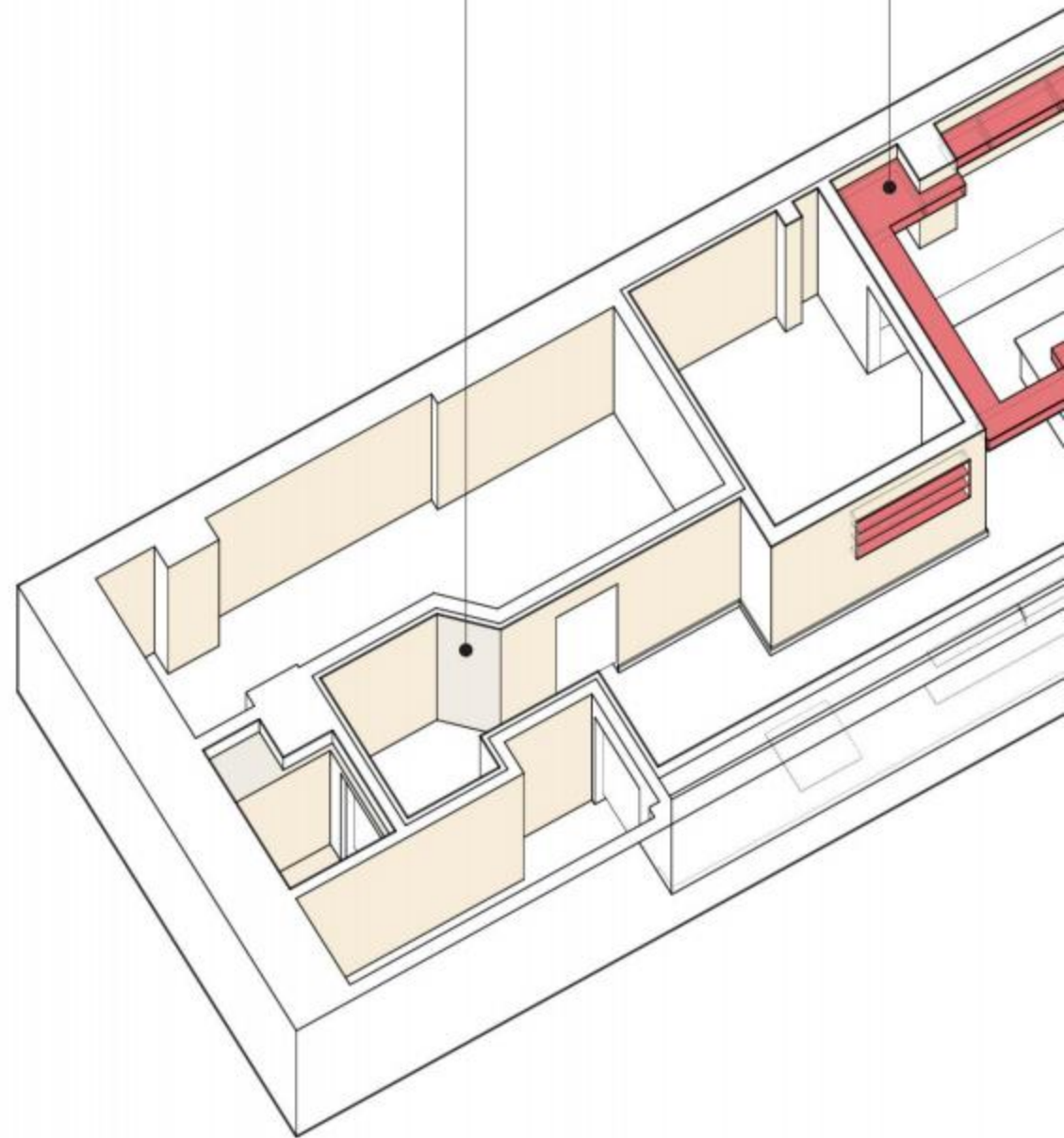
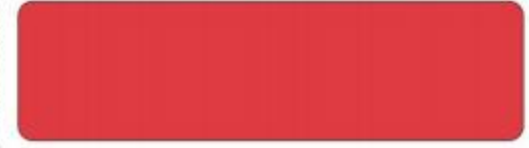

Patchwork Millwork

The red band descends from the shelves and column to a piece of millwork that formally looks old and aged. This wall will feature elaborate moldings from Dyke's lumber yard and non-working drawers in a mismatched array. Although the wood itself will look beat-up, the fresh color red will give new life to the artifact. This supports the idea of using the local Sugarhill history to foster a new culture, a new business. The patrons may believe you revived the millwork, or it was made from old drawers from what used to be in the space... it'll give the space some kind of history without looking dated.

Red seen through the window contrasts with the street above, and brings attention to a cafe hidden below grade.

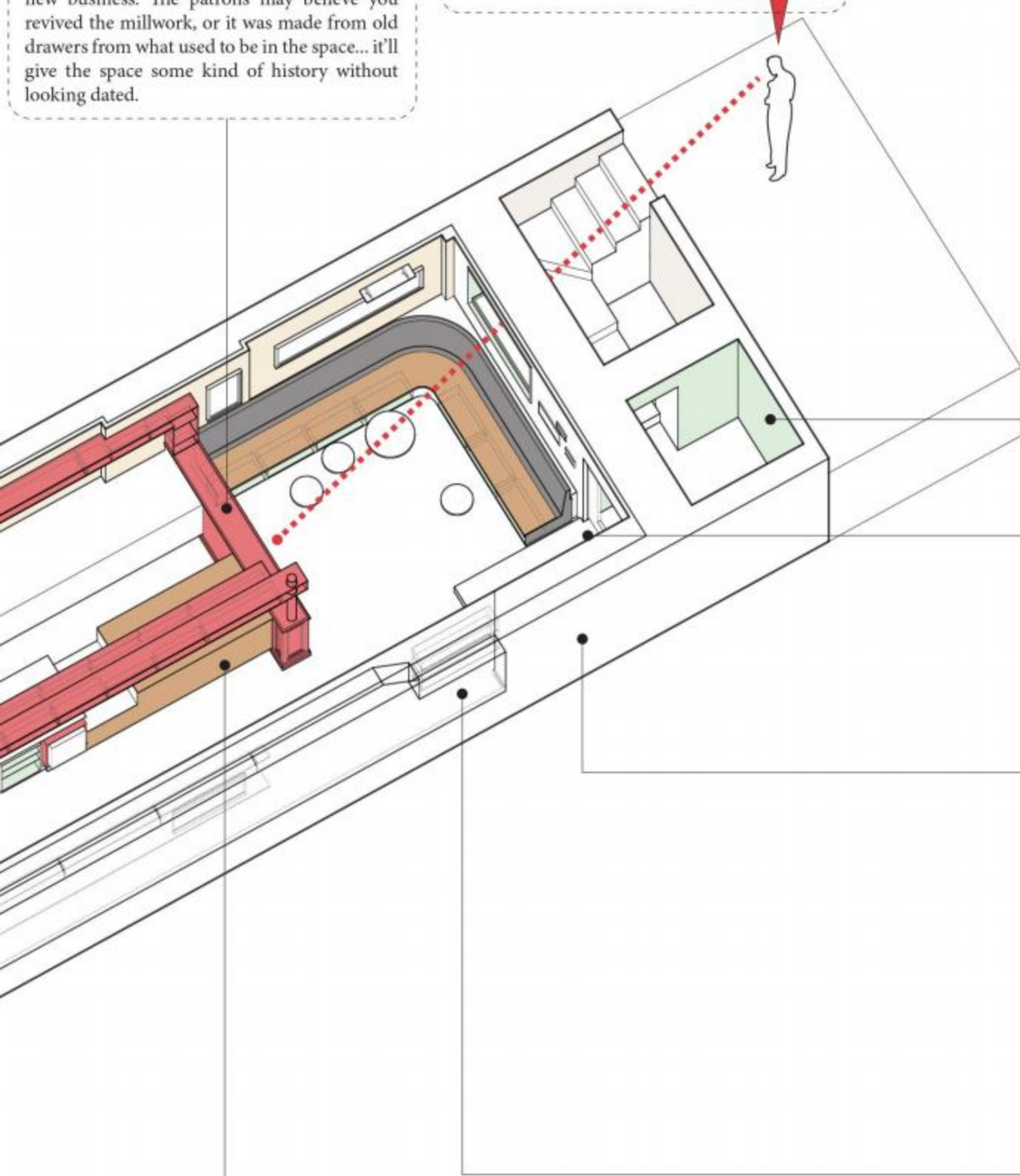

Dark grey is used for railings and metal brackets, adding depth to the palette at the space



Bright Vestibule

The cafe is located on a great street with lots of activity, but is situated at an inopportune elevation, below ground. Although 'underground' has hip connotations, we want to avoid creating a dingy basement aesthetic. Not many people will expect a cafe to be below grade, so we want to create a bright environment that disassociates the idea of going into the basement. It's not a 'man cave,' but an elegant cafe tucked underneath beautiful townhouses. The vestibule will be painted a mint green to give a subtle bright coloring before entering the actual space.

Base millwork, frames and reveals are painted brown to match the hue of the furniture and contrast the wood.



Canvas Pin-up Board

In order to create a sense of connection with the community, we envision a wall near the entrance to be used for fliers and posters as a means to communicate and project what's happening locally, and connect people through the coffee shop.

Mint as a secondary color adds highlight and luminosity to the space without competing for attention with the red.



The modern construction of the counter contrasts with the red faux-historic millwork, adding richness to the space. This also complements the modern coffee equipment that will be housed in plain sight to the patrons. The stepped construction allows the pastries to sit lower to eye level, and the accommodation establishes a meaningful relationship between the counter and object rather than just sitting atop.



Window Display

The space has a single window which is very limiting to the amount of visibility it will receive. The window creates a frame for the prominent display of red to draw attention from the street. But the window can also display the function of the space.

A trick we learned in Hobart, Tasmania is to use coffee as an architectural and sensorial material, putting the beans into planters and embedding plants in coffee mugs.



Seating Area

In the front of the cafe is the largest area of seating for the patrons. The target audience is locals looking for a great cup of coffee and students passing 145th Street to get to City College. Locals tend to travel light. Students on the other hand, travel like they're catching a flight. To avoid the inconvenience of backpacks consuming space for seating, the design includes a underside storage for the wall bench. This allows students to stow away the backpacks, and let the space remain open and uncluttered.

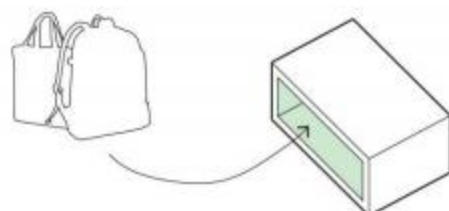

Taking advantage of the wood joists, the full wood ceiling creates a warm space without too much surface coverage.





**Industry West
Flanders Chair**

A new twist, a modern update on a classic design. An iteration of the Marais chair, with similar teak wood seat and galvanized finish. Welded steel adds durability to an archetypal form. Rubber feet, stackable (up to 10). Base dimensions: 18"W, 18"D, 33.5"H. Seat dimensions: 14.5"W, 14.5"D, 18"H



Hairpin Legs

A beautiful design that limits the amount of material required while keeping the strength of traditional table legs. It is easy to purchase these legs and affix them to a table top, which enables variety and flexibility. A clean, modern design, that prevents the cafe space from feeling cluttered.



L1, LED Tube Light

The lighting is hidden within a built-out shell in the millwork. This way, obstructions at the front counter is minimized, while lighting is consistent and bright enough for the transactions taking place and the display of the goods being sold. LED lights are more favorable than their fluorescent counterparts for their longer lifespans and better colors.



Schoolhouse Electric + Supply Co.

L2, Isaac Sconce- Short Arm

A hardwired fixture made of steel and custom lathe. Vintage-inspired materials with classic arcing geometries. A simple and elegant fixture. A G16 petite bulb is recommended for this sconce. The clear bulb complements a wide range of fixtures from vintage to modern.

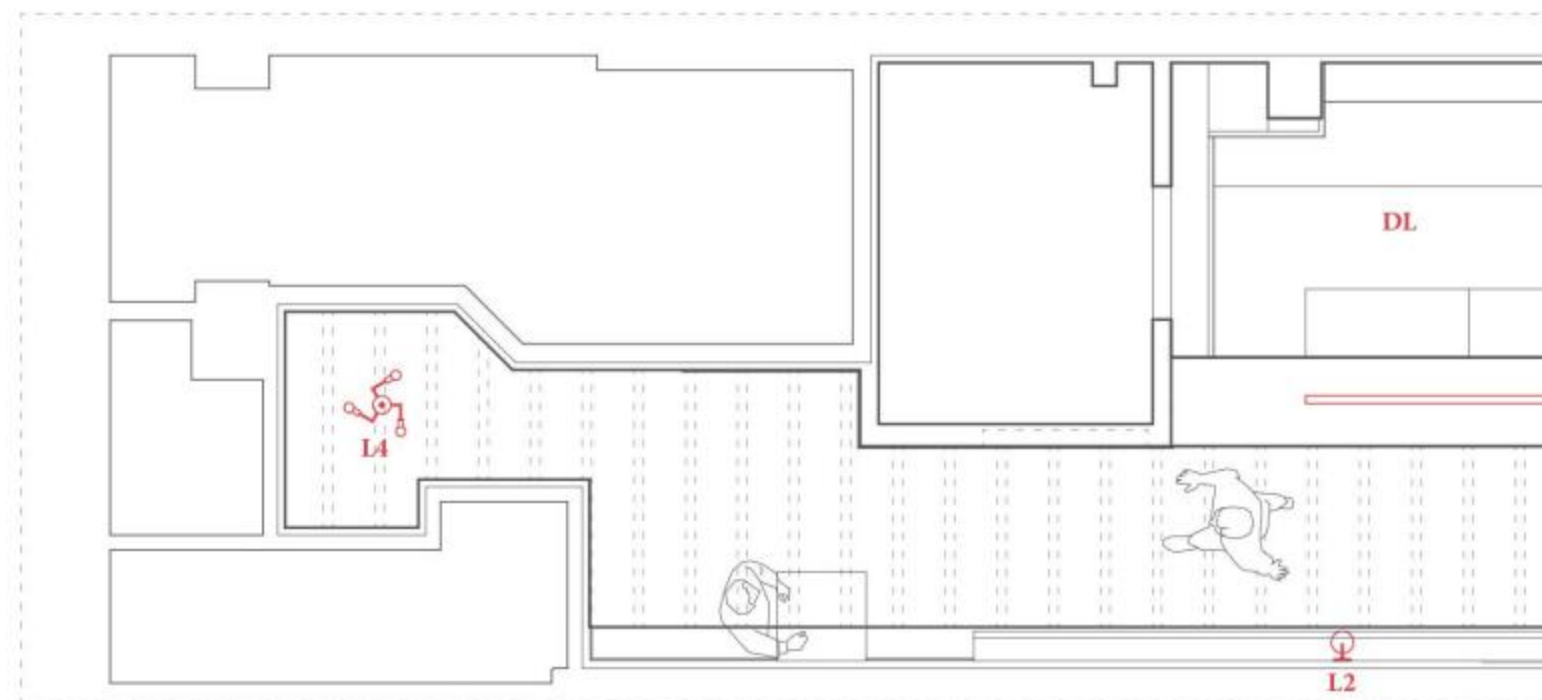
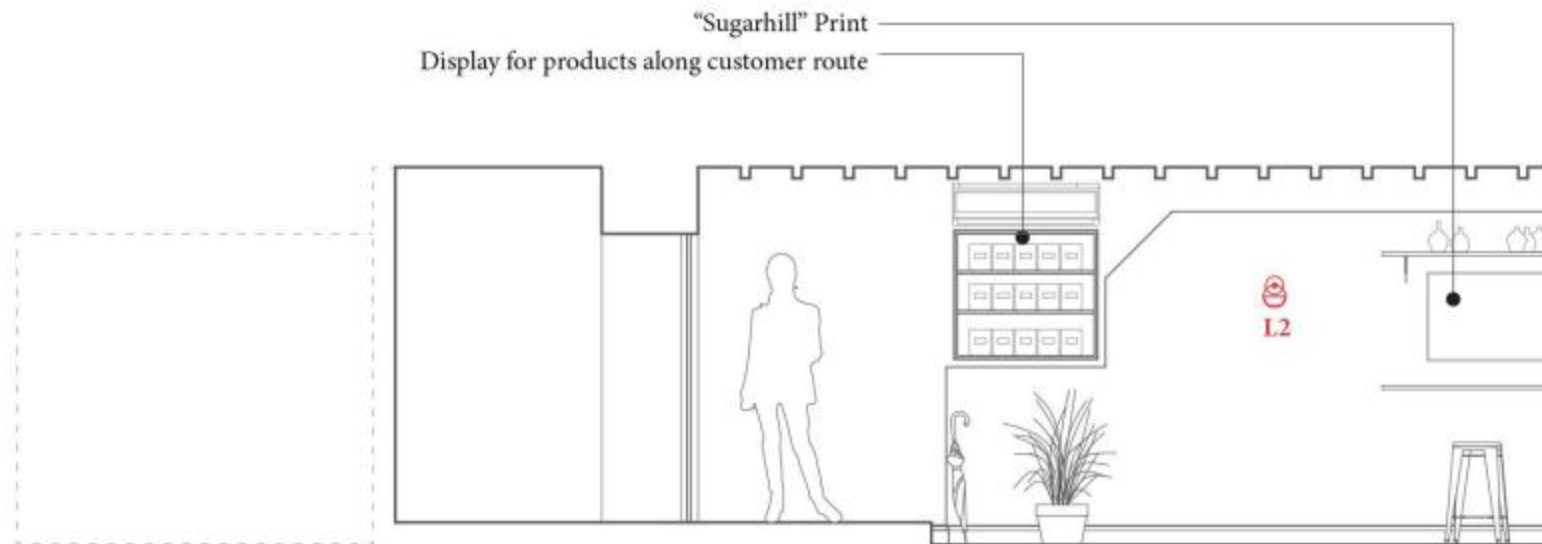
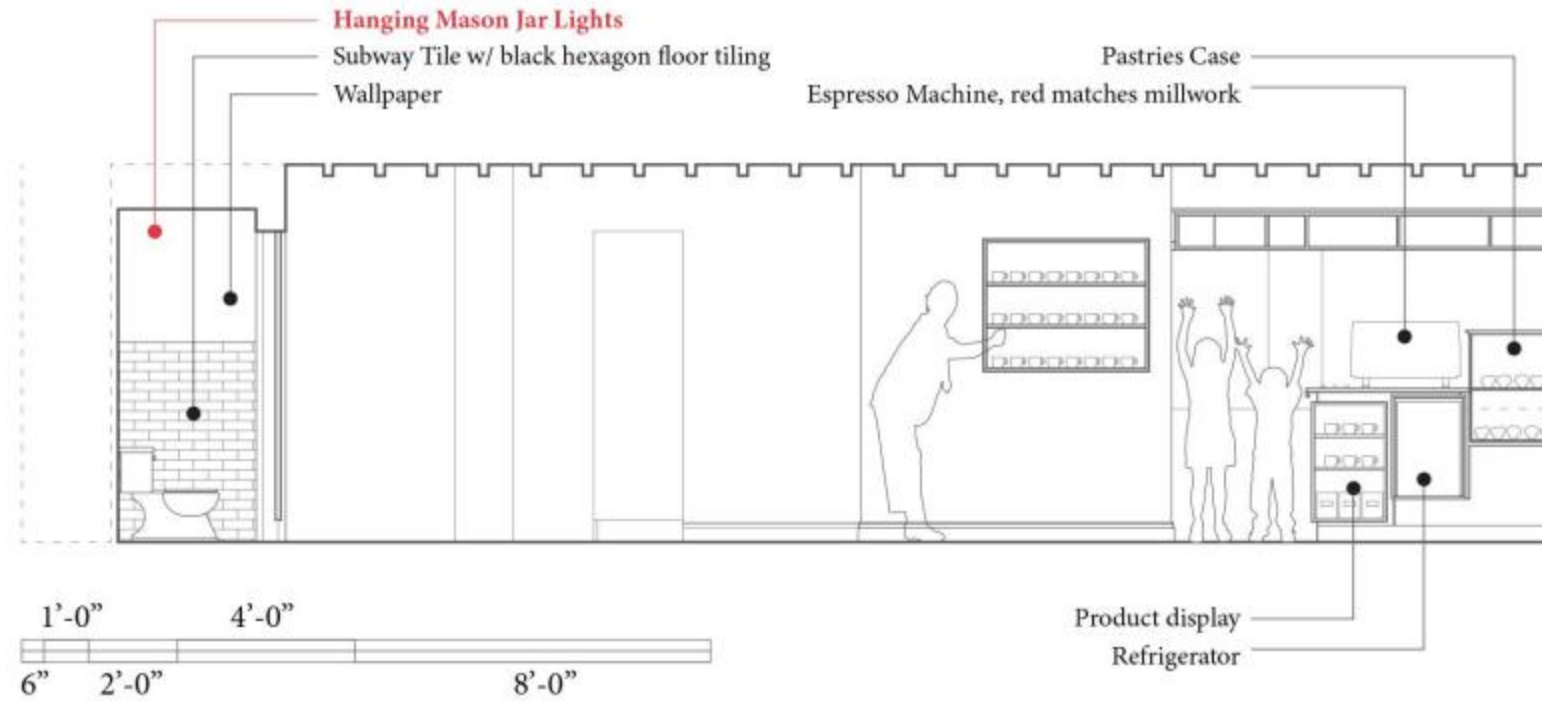

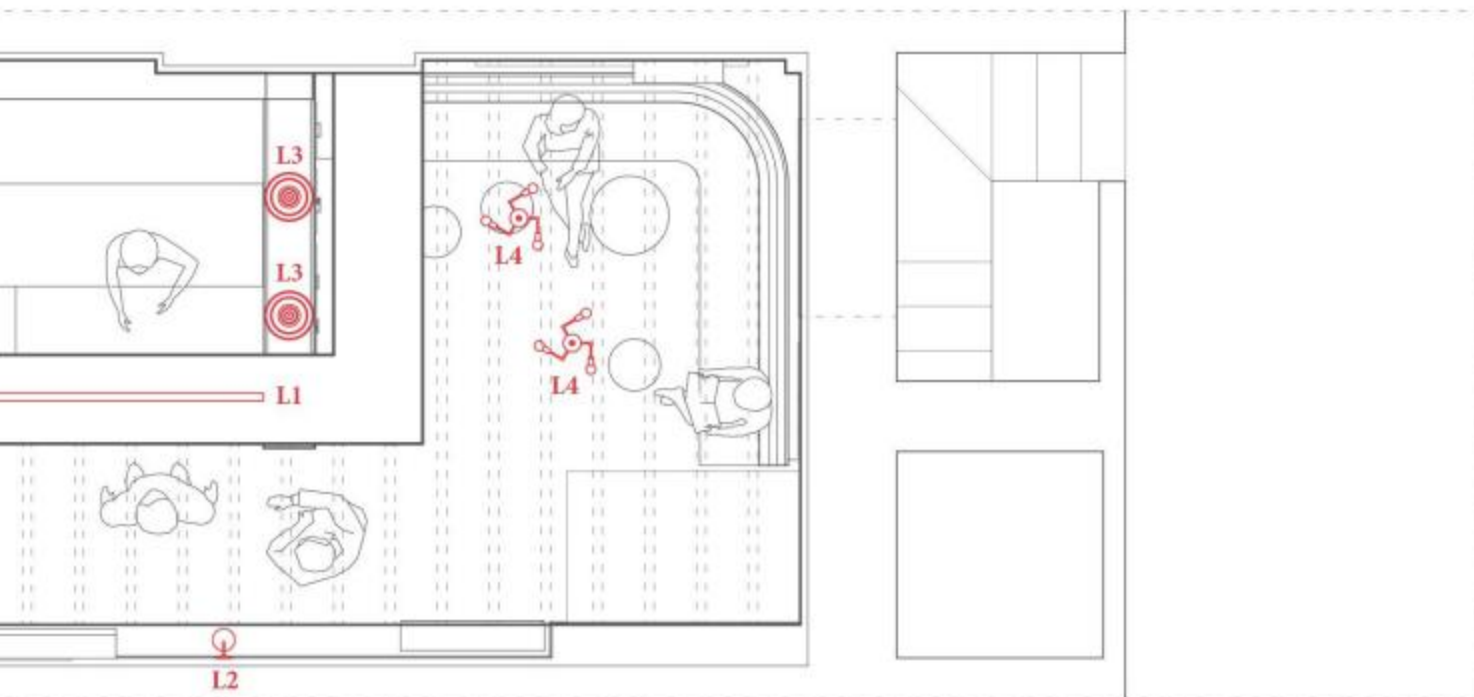
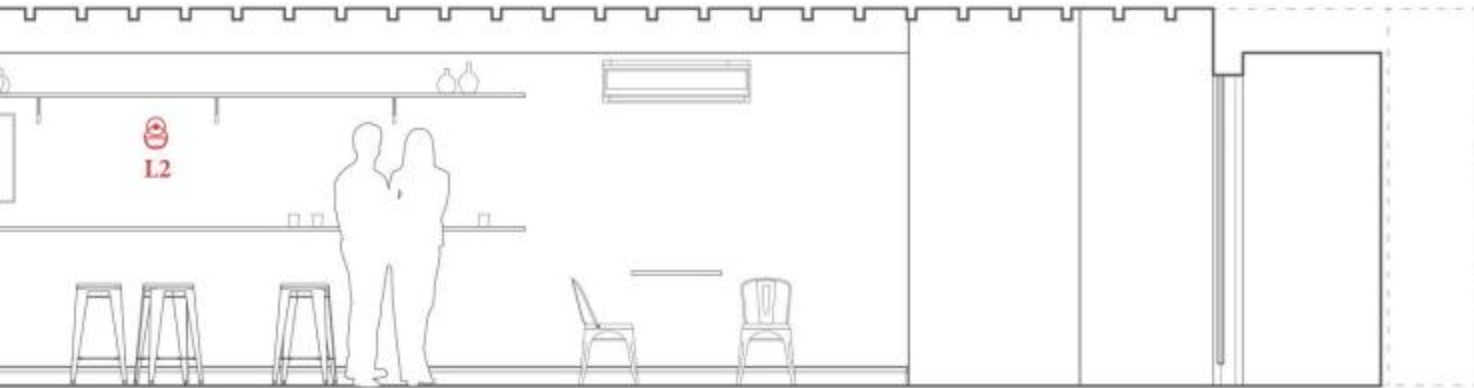
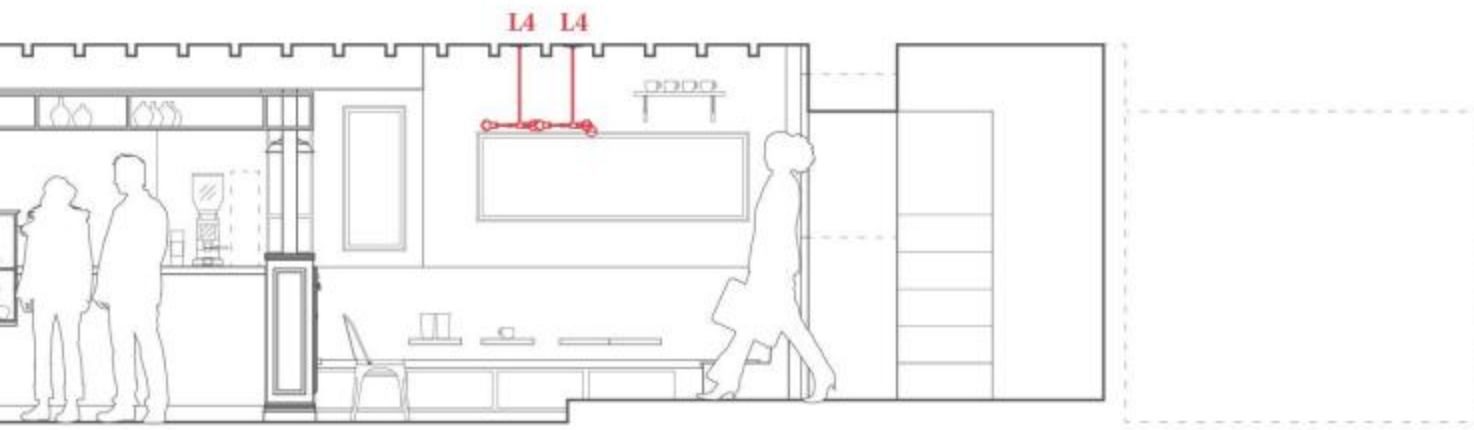

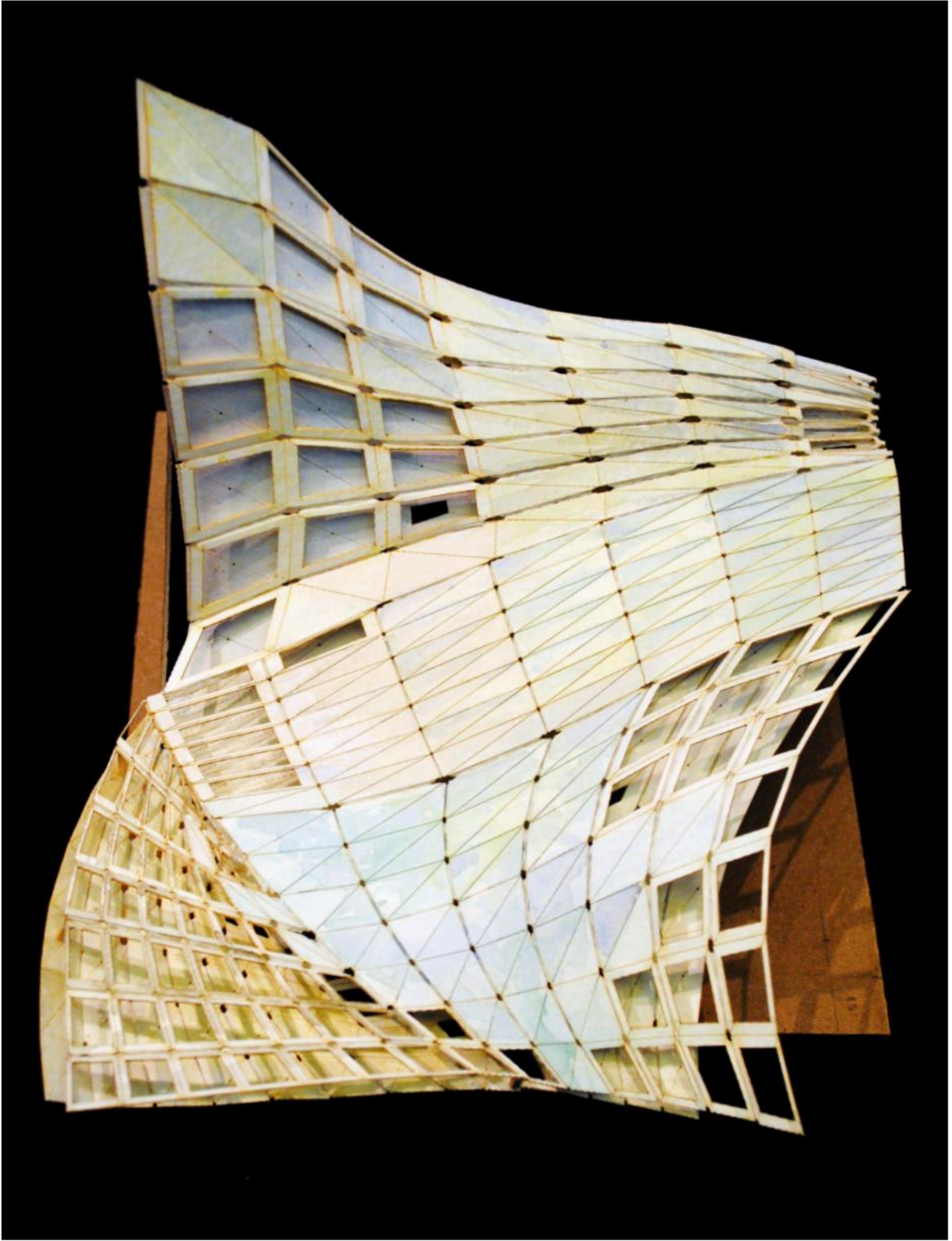

SPIRITUAL COLLOQUY

The City College of New York, CUNY

Undergraduate Thesis

2012-2013 Academic Year

The sacred is experienced individually, yet we covet an architecture to express communal identity and tradition; a quest for concepts of the ethereal conceived in material form. A Trappist monastery situated in New York City's Lower East Side becomes an inquiry on the caliber and condition of religious architecture and its associated activities in our contemporary time.

For centuries, monks have interacted with their contiguous societies to procure a conversation between two parties in a reciprocal, respectful way. The discourse appears at different scales: in relationships between individuals and their spiritual dispositions, between occupants of the Lower East Side and the monks, between each of these groups and the spaces of the city, between the appropriation of secular and holy spaces.

Trappist monks are in the business of serving God by serving one another and their neighbors. To translate and transpose their sentiment would create an architecture that approaches patterns of profound movement: from meandering through market stalls and gardens, to steps synchronized with the recitation of prayer in the protected cloister, to the journey from the secluded worlds of the cells to the collective world of society. The experience of meandering through the architecture is a spiritual one. It is a way to remove oneself from the clamor and commotion of modern life.

Monastery:

Cloister + Enclosed Garden: 4,325 sf
Church: 2,500 sf
Choir: 1,230 sf
Sacristy: 210 sf
Chapter House: 1,000 sf
Refectory: 2,400 sf
Kitchen: 1,200 sf
Reading Room: 1,300 sf
Dormitories: (30) 300 sf per: 9,000 sf
Guest Quarters: (15) 300 sf per: 4,500 sf

Community:

Open Market: 14,000 sf
Urban Farm: 9,500 sf
Production and Storage Facilities: 4,000 sf
Public Rest Rooms: 465 sf
Mechanical Electrical Facilities: 600 sf
Janatorial Facilities: 400 sf
Building Maintenance Facilities: 200 sf

Subtotal: 56,830 sf

Total: 65,350 sf

Jeremy Edmiston, critic

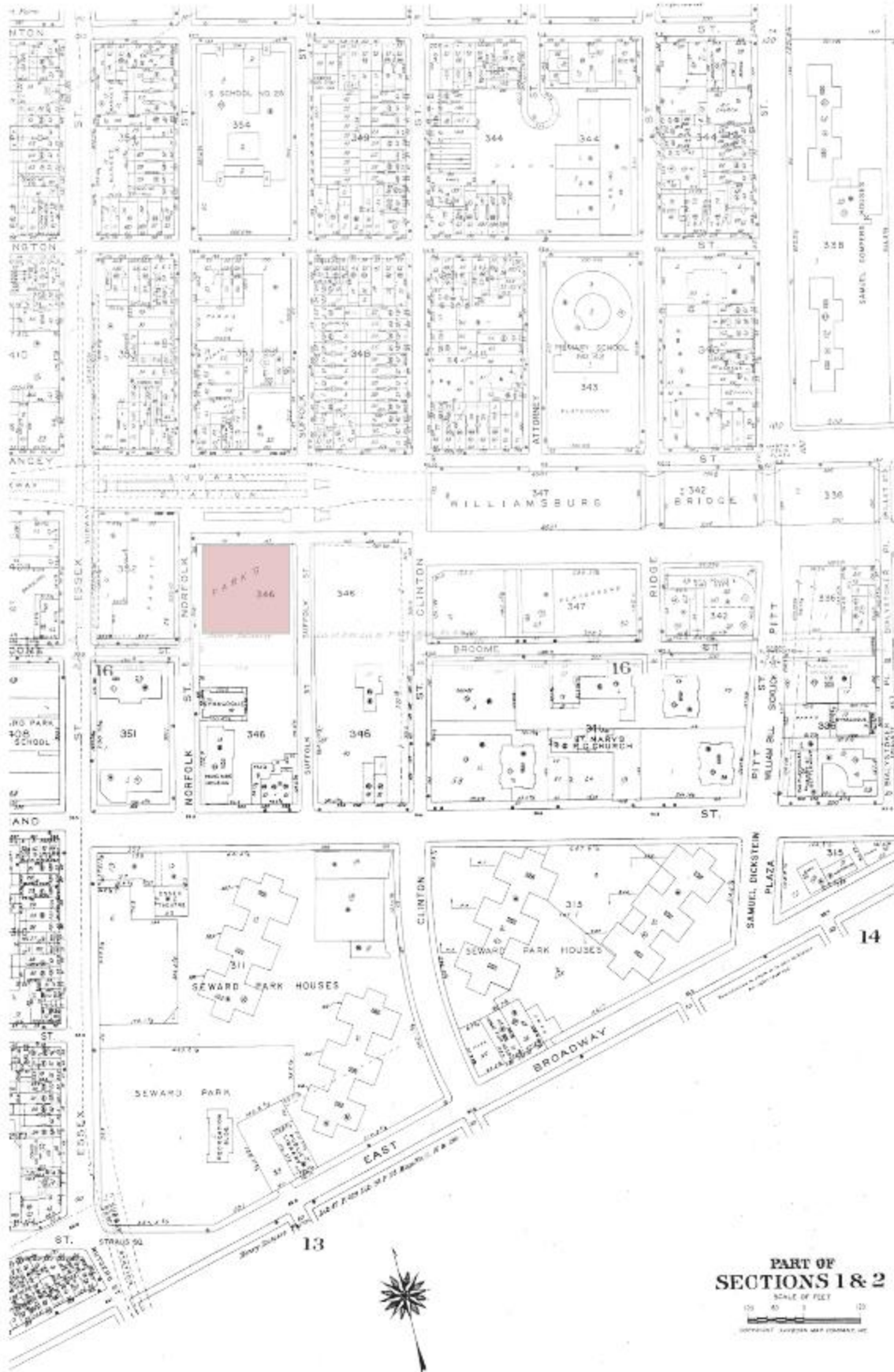

The Lower East Side is one of the oldest neighborhoods in New York City. Historically and culturally heterogeneous, the community has traditionally been comprised of lower middle class occupants. The recent rise in gentrification creates a sore point: as the gap between poverty and affluence broadens, the social tensions, frustrations, and economic disparities escalate.

There is a level of inaccessibility to local affordable fresh fruits and vegetables, and many NYC neighborhoods are experiencing widespread rates of diet-related diseases. To link provincial farmers and merchants with the strapped inhabitants of the LES would abate this matter. The monks fulfill these roles.

The architecture seeks to frame the site, reclaim vacant grounds, and reactivate movement after the decay and grit generated as byproduct of widening economic divide. Coded landscapes: opposite, a mapping of population characteristics by household income. A social topography of the Lower East Side.

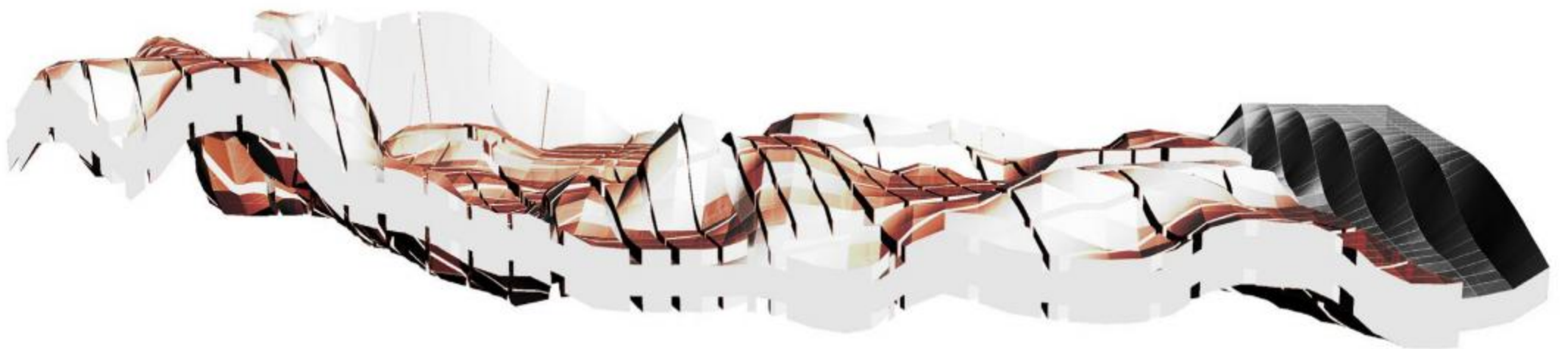
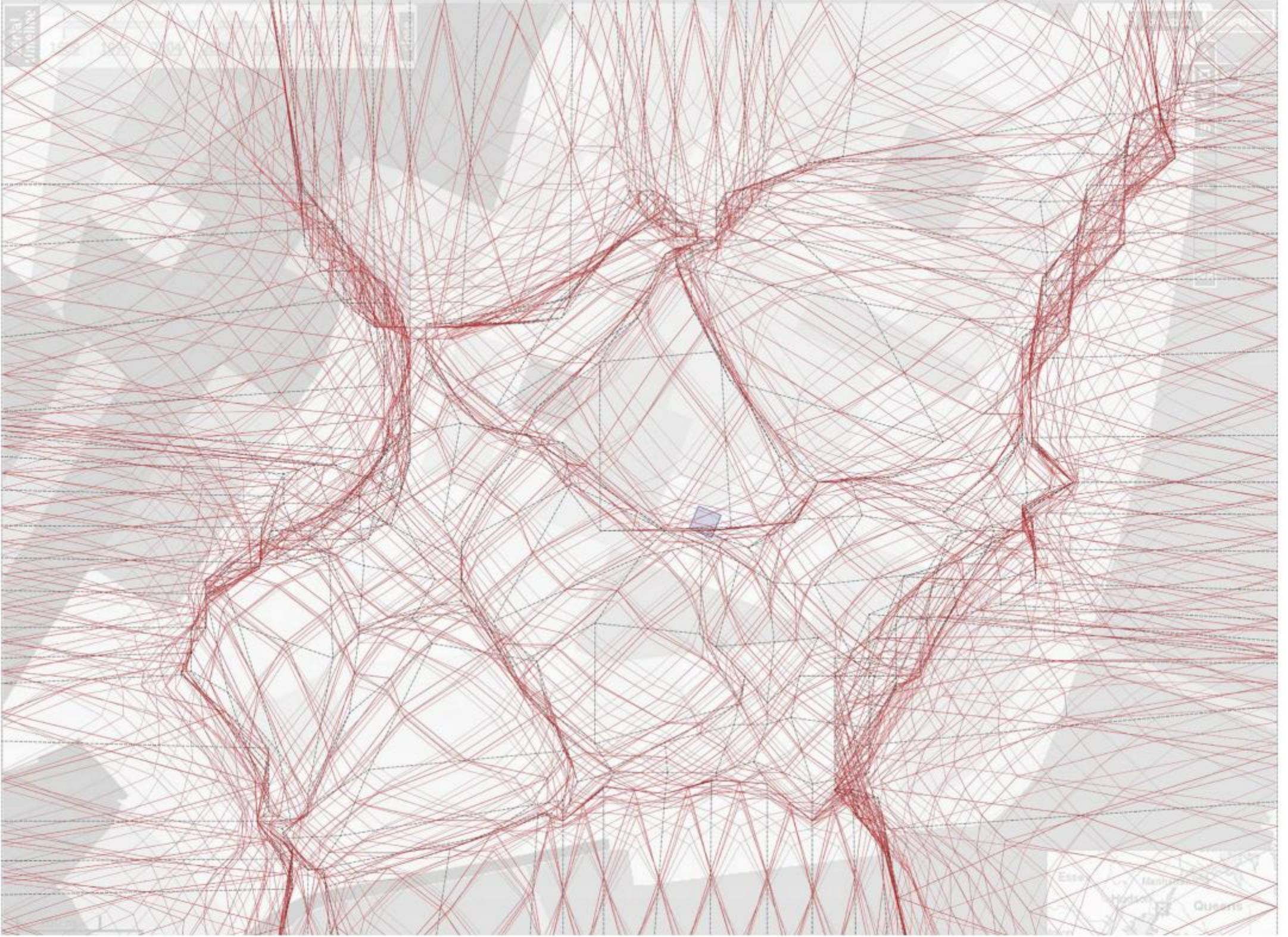



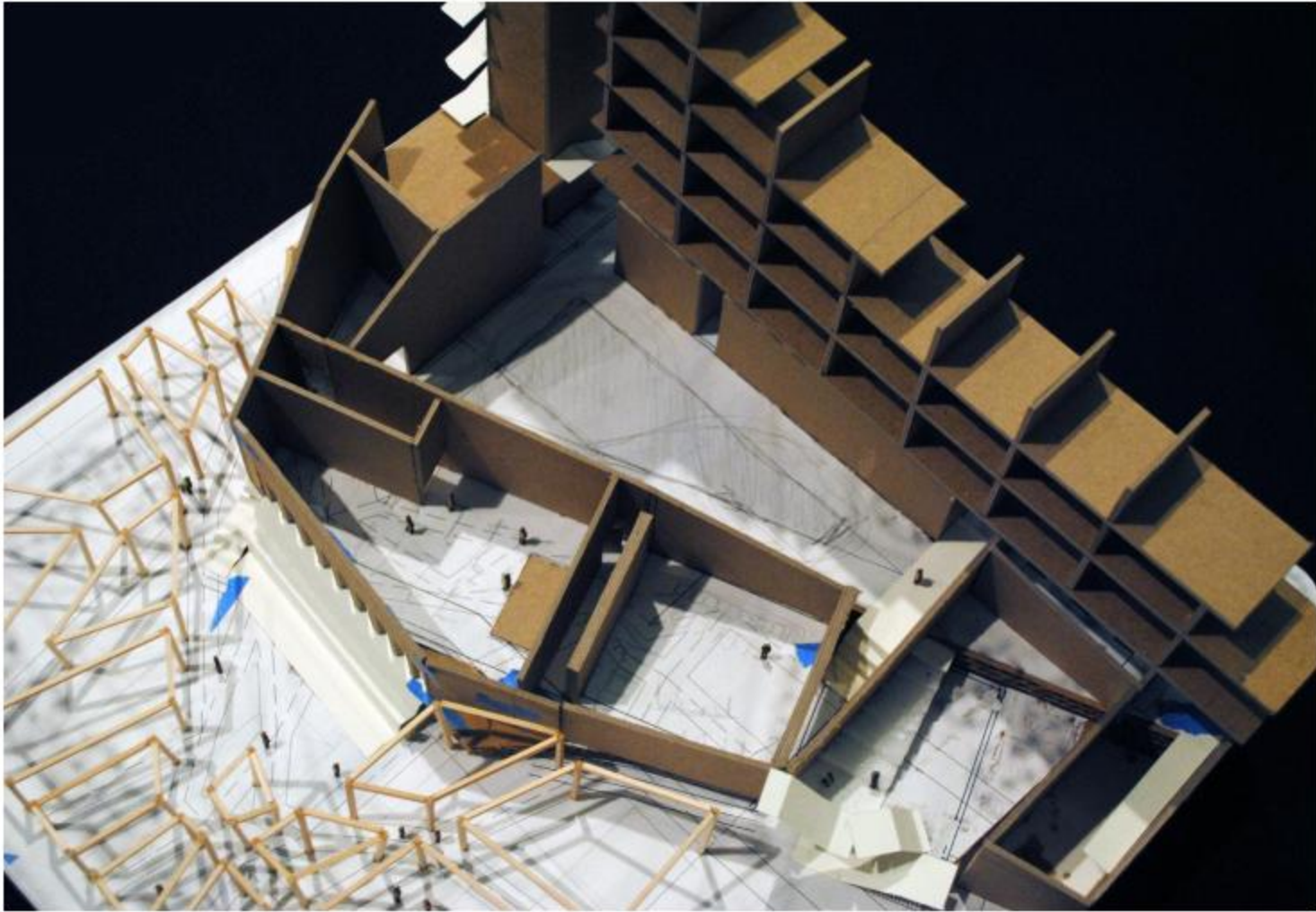

A steel frame and columns comprise the primary structure. Secondary and tertiary fittings of shades, screens, glass, insulation, and other materials amass to create a system of rich layers, at once delicate yet permanent. The system maintains a balance and cohesiveness across its component parts. The continuous surface drapes the different levels of spatial organization and creates one resolute form.

1. Laminated glass, 2. Opaque panels, shades external to glass, 3. Demountable screens, 4. Horticultural containers, 5. Walkways, 6. Spaceframe structure, 7. Fritted insulated glass, 8. Clear insulated glass

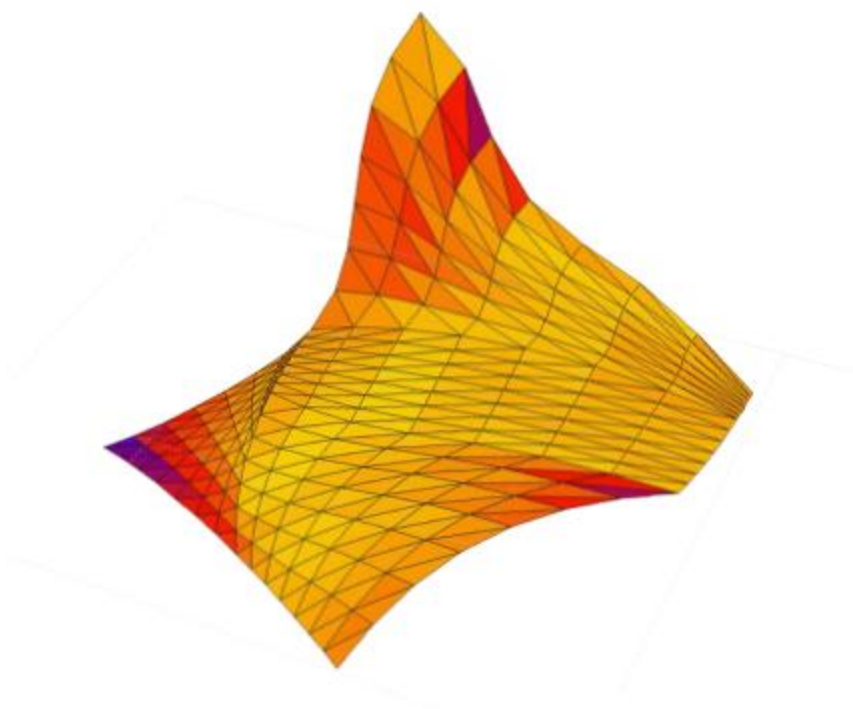

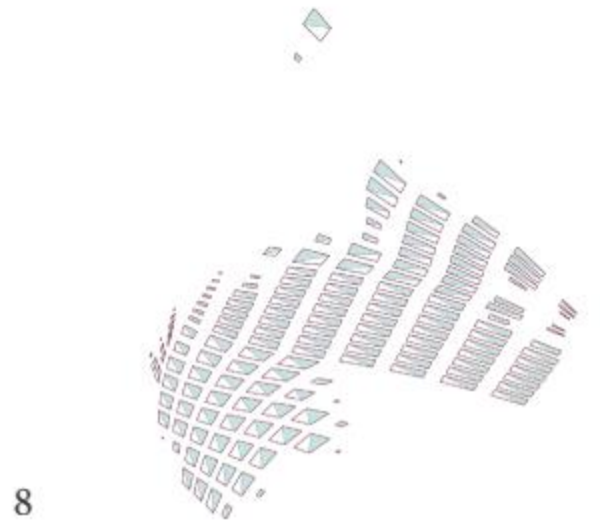
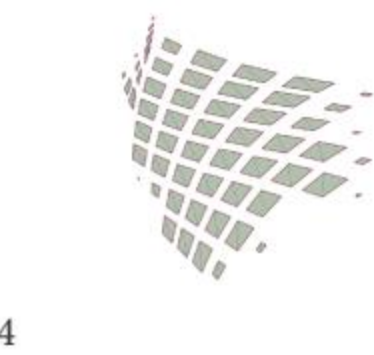
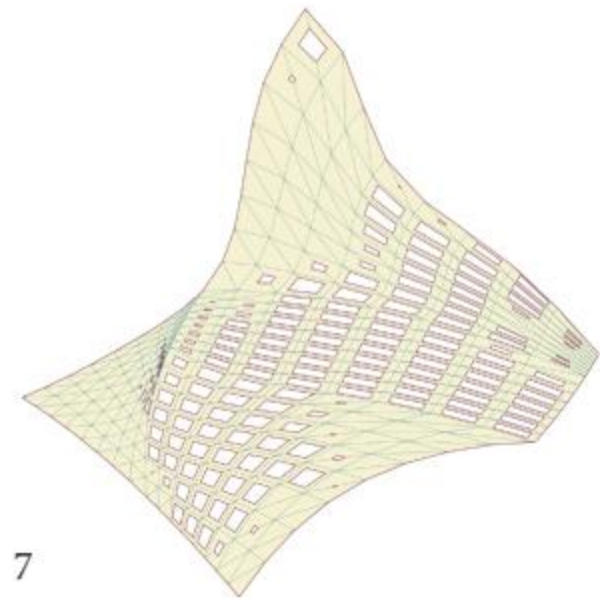
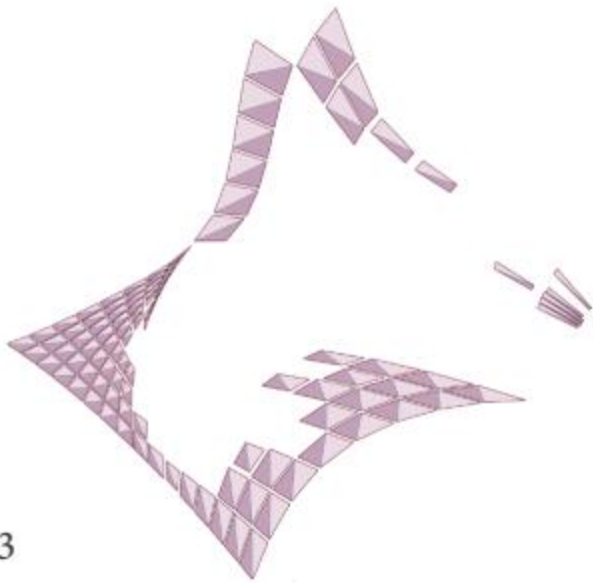
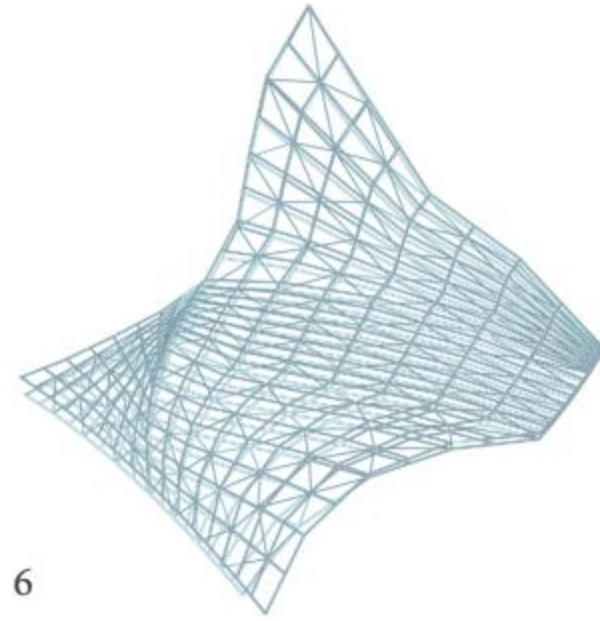
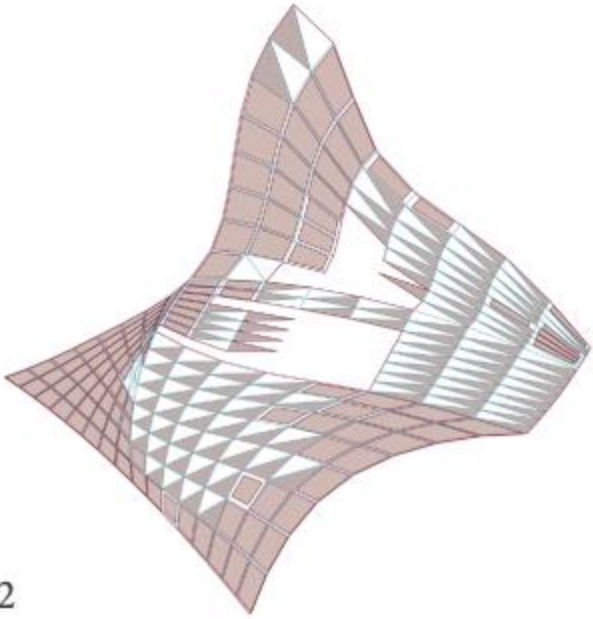
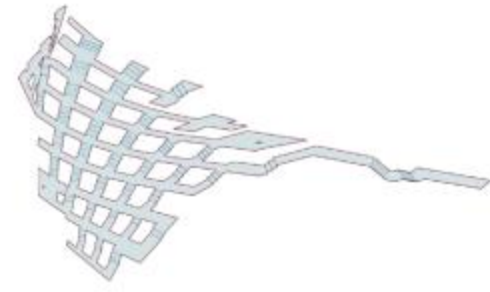
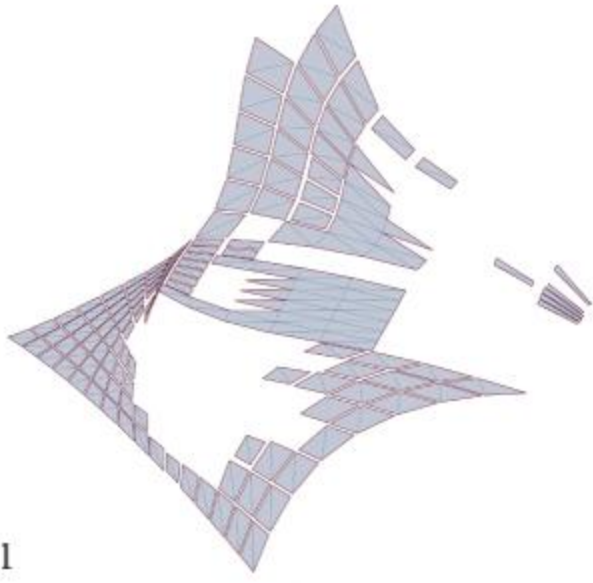

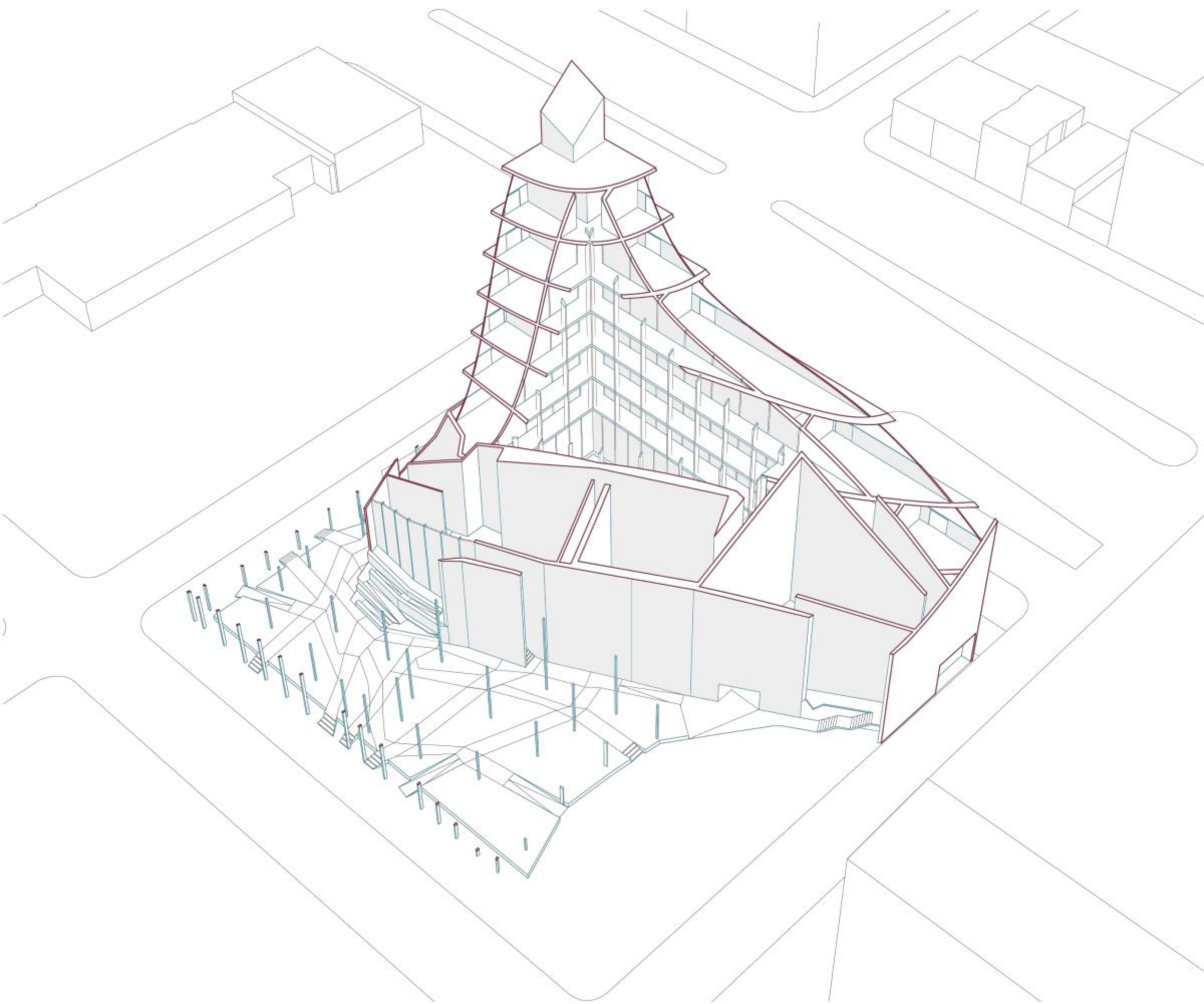

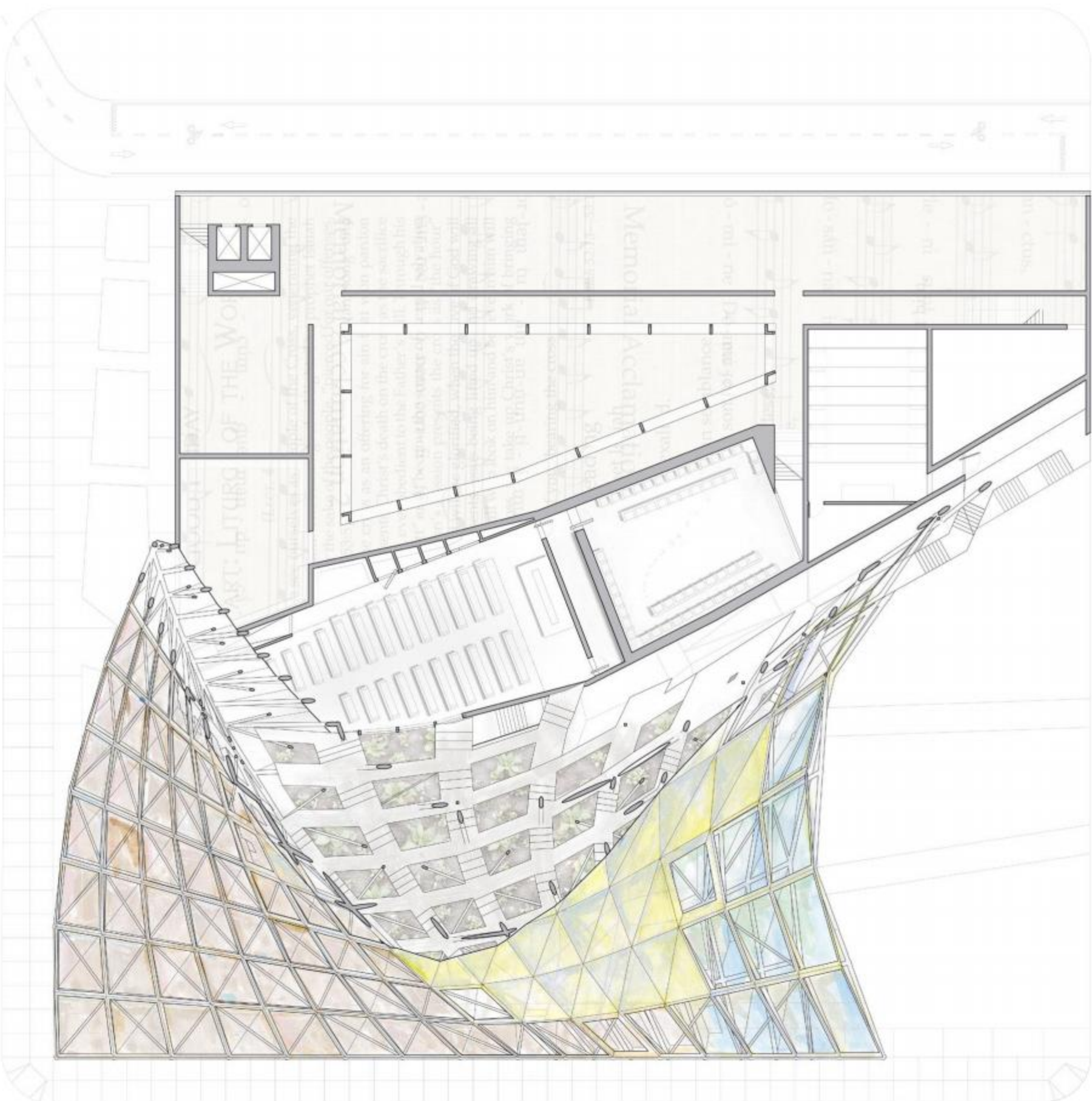

...during the anointing,
...to the assembly.

March 29
**THE PASSION OF THE
GOOD FRIDAY**
LITURGY OF THE

...the people of this Church
...the night
...the death on the cross
...the Father's will
...the Spirit
...the Son
...the Holy Spirit
...the Father
...the Son
...the Holy Spirit

...the work of bringing
...the cross

...the night
...the Father
...the Son
...the Holy Spirit

...the night
...the Father
...the Son
...the Holy Spirit

...the night
...the Father
...the Son
...the Holy Spirit

...the night
...the Father
...the Son
...the Holy Spirit

...the night
...the Father
...the Son
...the Holy Spirit

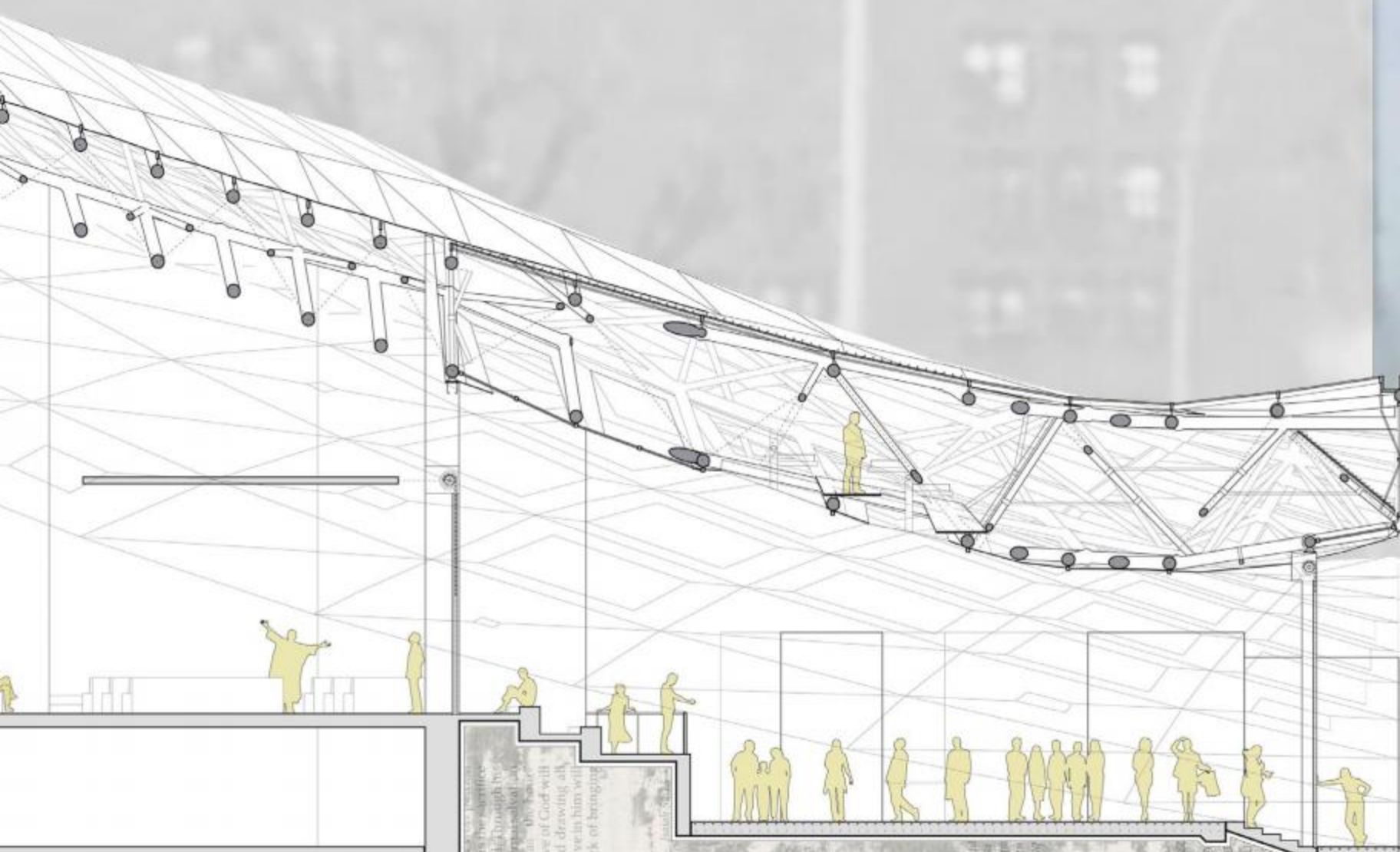



HAPTIC PERMUTATIONS

The City College of New York, CUNY

Undergraduate Design Studio

Fall 2009

This exercise sought to take familiar objects and transpose their form and material as a way to collapse the concepts of time, reality, and perception. We're getting a grip on the everyday ritual.

The individual apparatus is a site specific, palpable depiction of the interaction between the hand and the object. It examines moments of daily life; the moment of contact between object and user serves as a method of disrupting conventions and habits of use. These tactile photographs create comprehension of the act by removing the object. Design as a function of the research. The iterative research of this exercise illustrates the permutable forms that result from grasping a toothbrush in one's hand.

"The hand registers and measures the pulse of lived reality." Juhani Pallasmaa

"The practice of ritual effectively transmits knowledge across time because it is patterned and alliterative. Such repetition [...] binds together the psychic, social, natural, and cultural orders that the exigencies of life tear apart. Mindful ritual [...] is a material space of possibility that opens within a body of continuity." Sarah Robinson

Antonio Furgiuele, critic



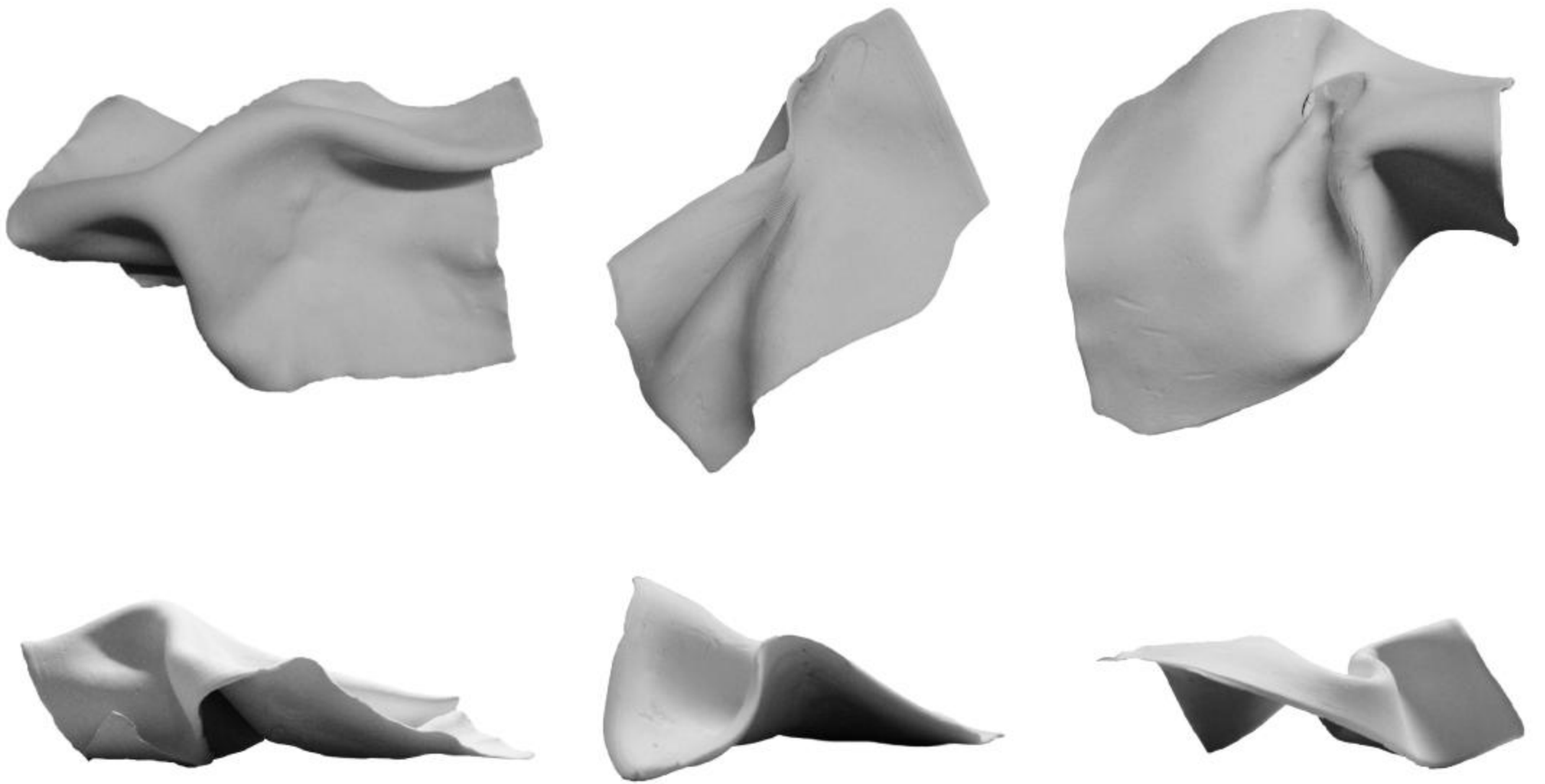



PAPAHANAUMOKUAKEA

DARK ECOLOGY and STRANGE TOYS

Yale School of Architecture

Fall 2016 Semester

This project explores the relationship between architecture and the frequently shifting ecologies of coastal boundaries through the design of a single building.

Papahānaumokuākea is the largest marine conservation area in the United States, a UNESCO world heritage site, and as of 2006 a designated U.S. National Monument. It is located northwest of the westernmost and most remote Hawaiʻian Island of Kauaʻi. The entity is geologically and ecologically unique in the world, covering roughly 140,000 square miles of reefs, atolls, shallows, and deep sea in the Pacific Ocean. It contains forms of life found nowhere else on earth.

Kauaʻi's Na Pali Coast is a pristine fiction; ostensibly pure and positively unthinkable. It is important because it is wild. It is self-willed. The environment teems with great, shifting, complex diversity of both human and nonhuman life. No one species dominates the mix.

What is at once perceived of as being natural today is actually the ecological result of antecedent actions, and we must abandon our romanticized view of a nature that was once whole and now has been broken by anthropogenic influence. When trying to re-contextualize the meaning of nature as the basis for a new theoretical framework of ecology, we must seek new answers to the question of what "wild nature" really is. The project considers relational models of ecological spatiality and aims to structurally infuse its context. It confronts the unknown and unknowable.

The lighthouse acts as a beacon for activity both above and below the surface of the water, inviting curiosity through decontextualization and refamiliarization. There is a passage port, a series of docks and launch sites for tourists and visitors to charter boats, hovercrafts, or aircrafts of varied scale to embark upon the waters of Papahānaumokuākea. The result is a new prototype that weaves the extremely biodiverse terrestrial and marine ecologies with the ecology of humans. The project is a testament to and celebration of a new kind of architecture that eludes traditional paradigms of rationalization or standardization. Instead, the focus is on perception, curiosity, and bewilderment.

Mark Foster Gage, critic



Freud's 1919 theory of the uncanny resonates here. A fright occurs in a moment when, because of doubling, repetition, or revelation, the familiar becomes disturbingly strange. Freud begins his argument with a discussion of the German words *heimlich* and *unheimlich*. *Heimlich* is usually translated as homeliness, but although it conveys the familiar and the comfortable, it can also refer to "what is concealed and kept hidden."

This second meaning opens up into *unheimlich* as a fright caused by a disturbing return to something that was once familiar. Thus, though the fright of the uncanny appears to be about something new or unfamiliar, in fact this uncanny element is actually nothing new or strange, but something that was long familiar to the psyche and was estranged from it only through being repressed.





Timothy Morton writes extensively on *hyperobjects* — entities of such vast temporal and spatial dimensions that they defeat traditional ideas about what a thing even is in the first place. In a grounding moment, the studio embarked on an outwardly endless hike across a different type of ecological boundary: the lava fields of Kilauea in the Hawai'i Volcano National Park. There was an immediate inability to situate the user into the environment.





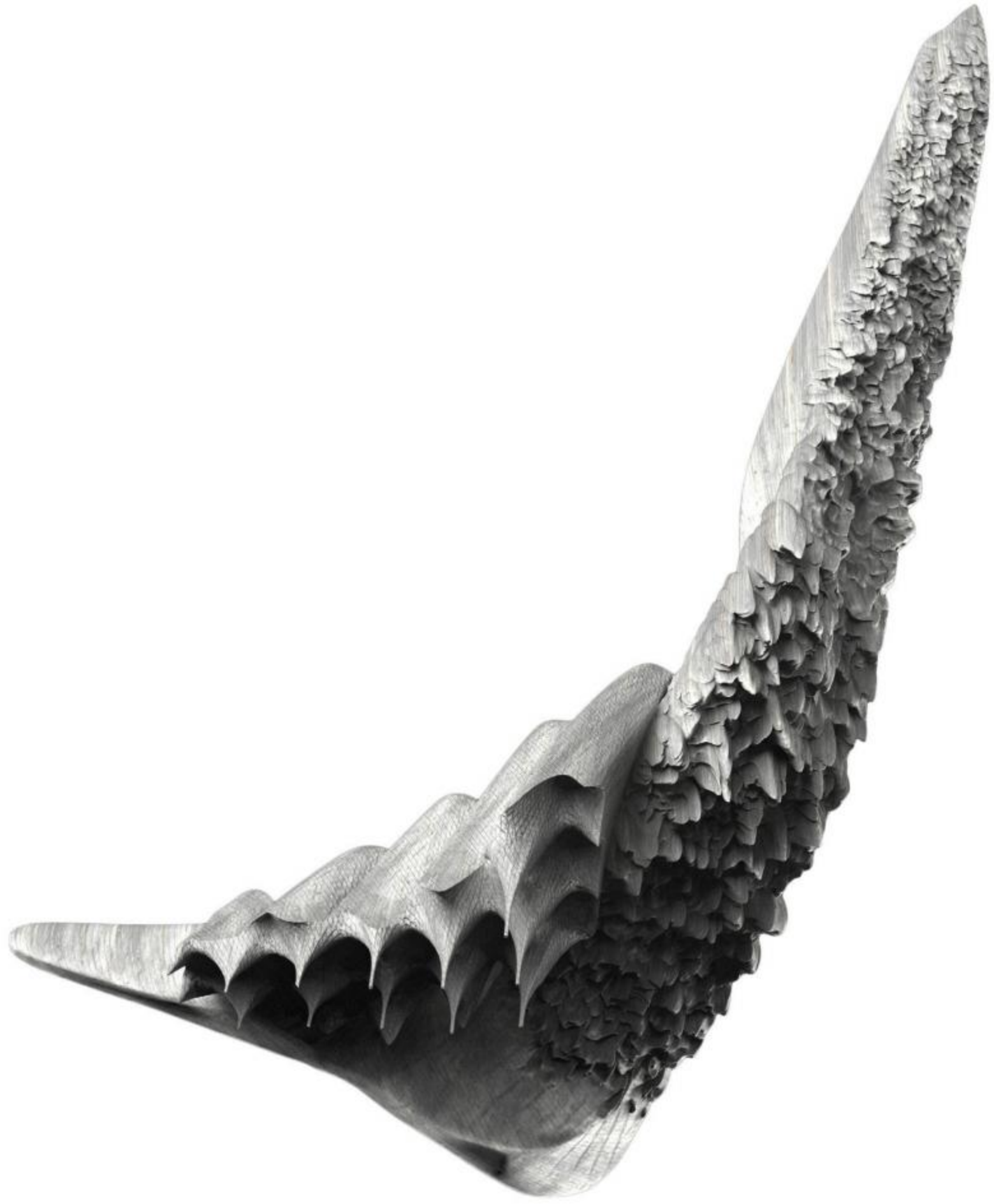





Bricks are a material with an intrinsic pattern. They add a layer of articulation; one that is less controlled. The site is an odd leftover. The lot is only 25-feet deep and has buildings abutting three sides, yet it sustains 40 feet of street frontage. The building is only one room deep, and does not meet the basic standards of cross ventilation, light, and open green space that are necessary for residential habitation. The site has little privacy, and no sense of domesticity.

The building will be made from materials characteristic of the historic neighborhood—brick, steel, glass, and cast iron—but used in a revolutionary fashion. The windows are carefully angled to increase the views up and down the street while decreasing the view into the house from the commercial building looming across the way. This has the effect of turning the brick facade into a continuous twisting surface. The brick acts as textile, cloaking and corbelling from the cast iron base up to the overhanging cornice.

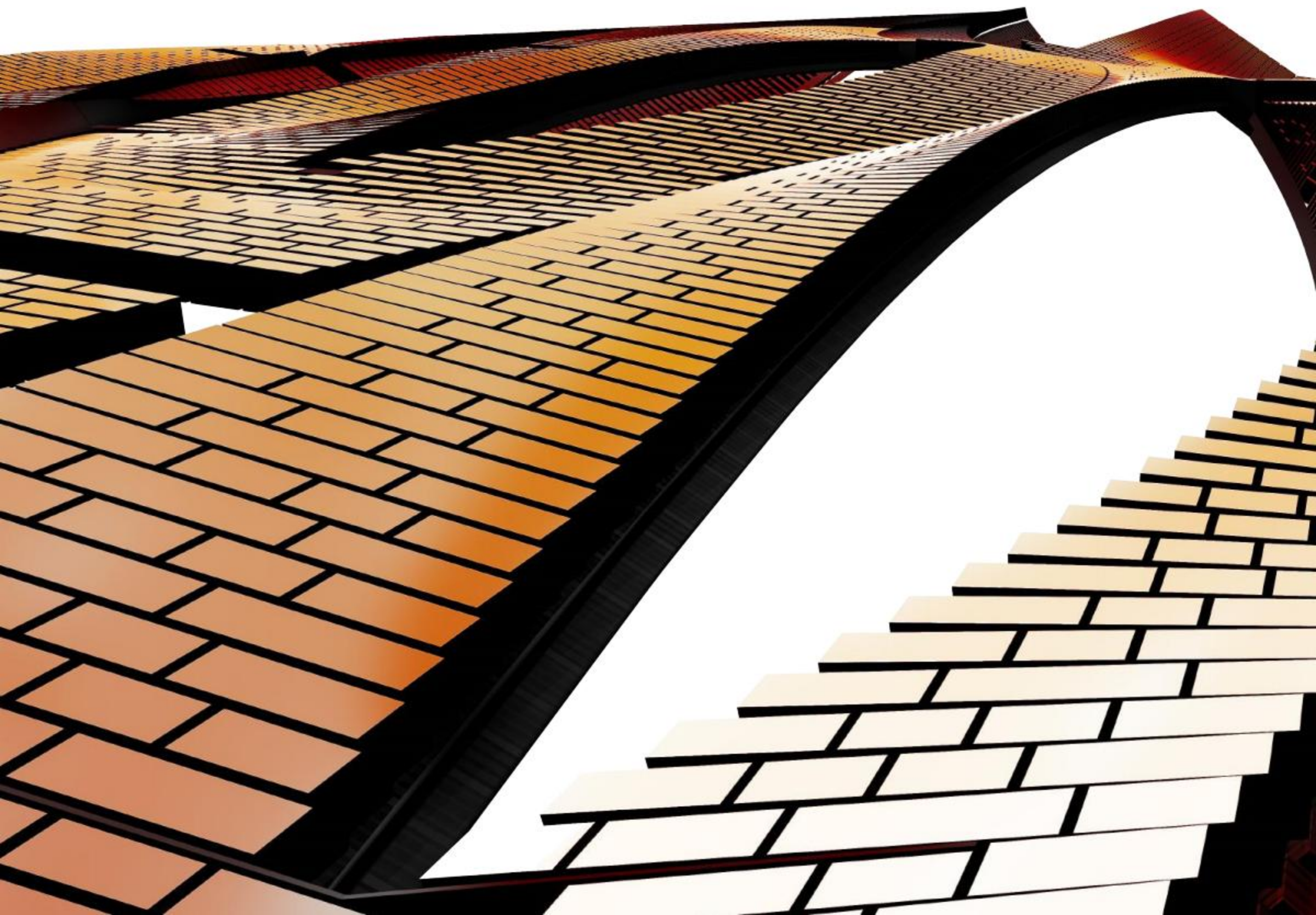

187F

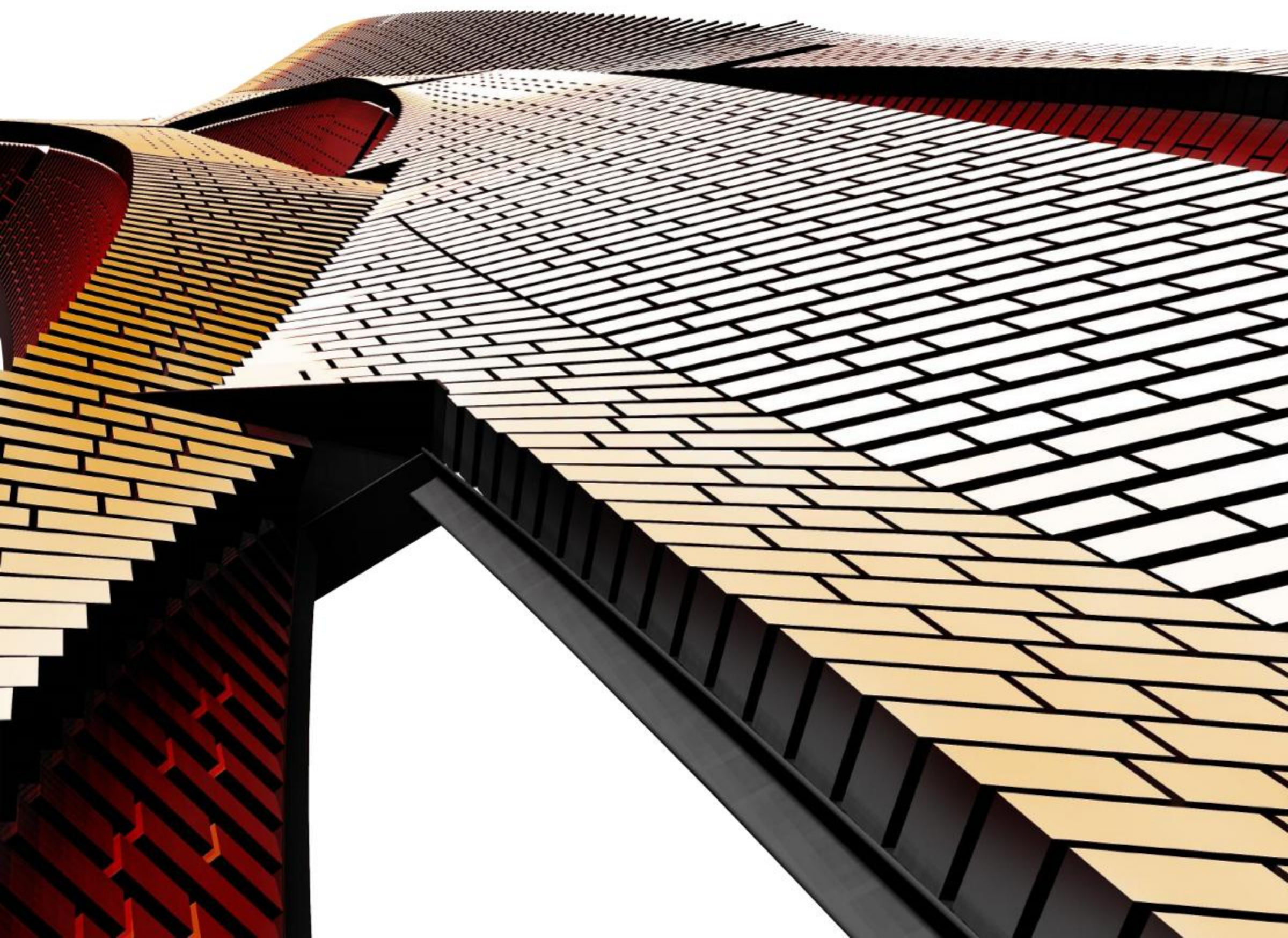

Notes:

All parts cut from 4' x 8' x 3-1/4" thick 1lb. EPS foam similar to part 14 cut files of drawings 1/A716 and 2/A716. Estimated total number of sheets is 210.

Estimated number of sheets by part:

01: 1.3	28: 9.4
02: 1.7	29: 5.4
03: 1.3	30: 0.7
04: 7.5	31: 0.4
05: 12.2	32: 0.5
06: 6.8	33: 1.0
07: 10.1	34: 0.3
08: 0.8	35: 1.7
09: 0.4	36: 1.1
10: 1.0	37: 4.2
11: 1.2	38: 3.0
12: 1.9	39: 5.7
13: 8.0	40: 9.3
14: 4.8	41: 7.5
15: 6.6	42: 13.2
16: 7.3	43: 1.1
17: 9.0	44: 0.8
18: 1.6	45: 1.6
19: 0.8	46: 2.6
20: 0.4	47: 2.0
21: 1.0	48: 3.5
22: 0.3	49: 1.1
23: 0.2	50: 1.3
24: 0.4	51: 2.6
25: 9.4	52: 5.0
26: 12.1	53: 3.3
27: 6.1	54: 7.2

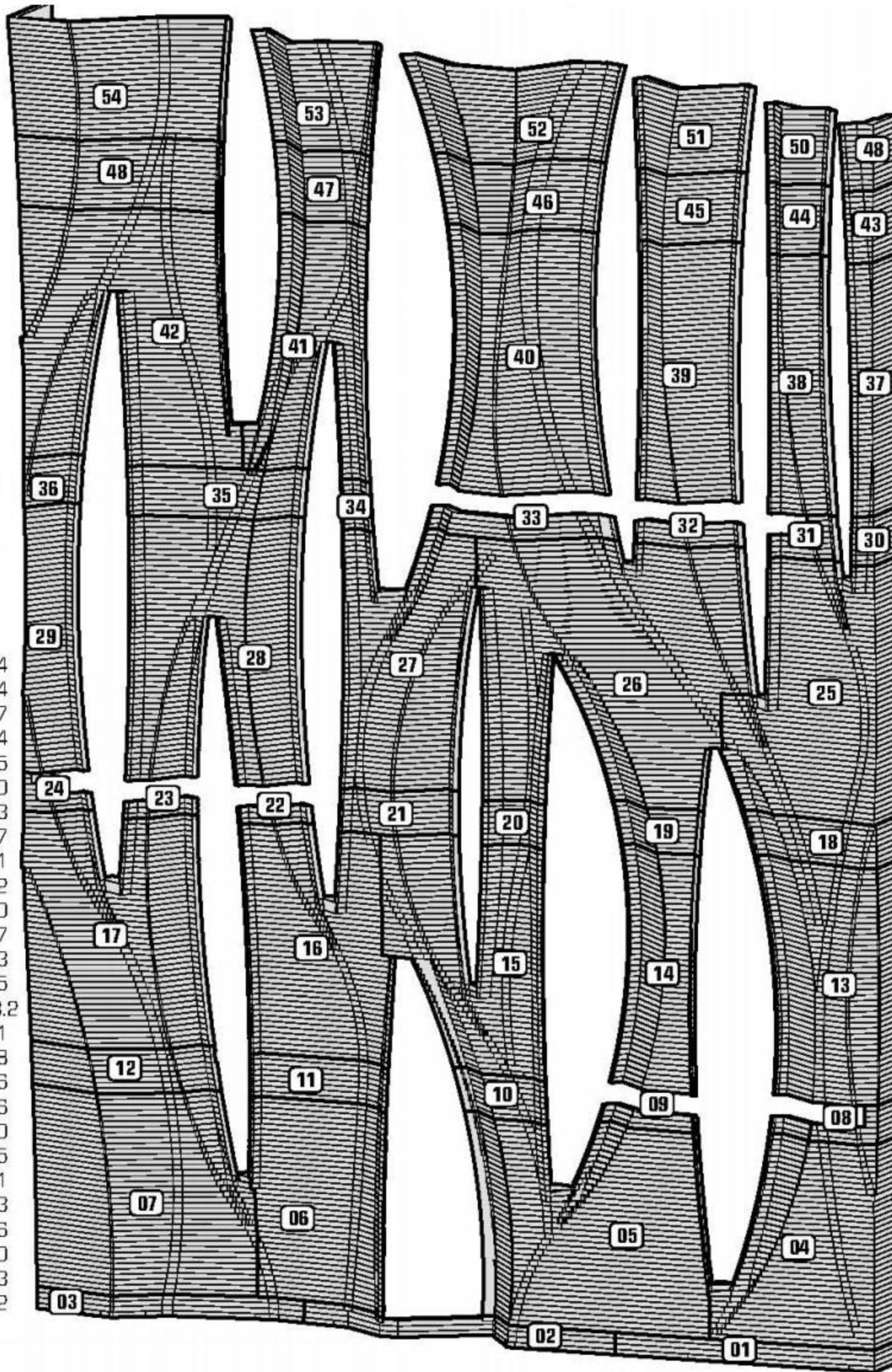

ISOMETRIC VIEW - EPS Foam Assemblies
Scale: n/a

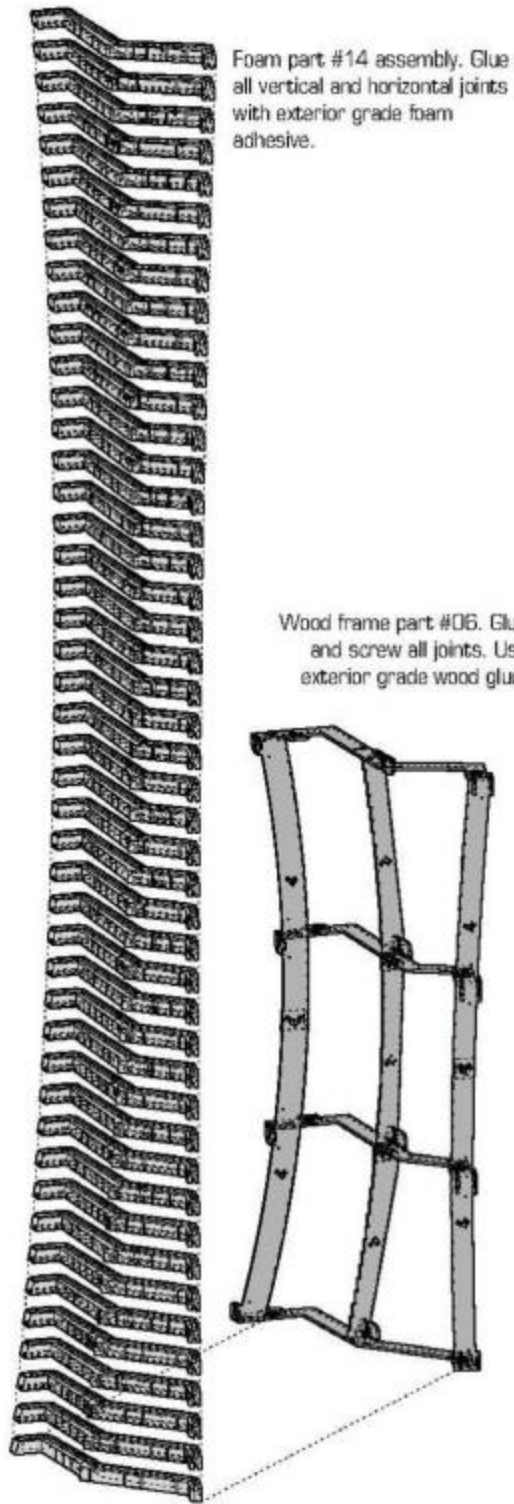

ISOMETRIC VIEW - Assembly
Scale: n/a

1
A717

Notes:
All 40 parts to be CNC cut from 4' x 8' x 3/4" sheets of Advantech. Estimated total sheet count is 21. Sheets are to be flipped on CNC bed to cut 1/4" deep pocket cuts like those depicted in drawings 1/A715, 2/A715 and 3/A715. All scarf joints between connecting parts are to be tight fitting joints.

Estimated number of sheets by part:

- 1: 3.5
- 2: 2.5
- 3: 2.5
- 4: 2.5
- 5: 2.5
- 6: 2.5
- 7: 2.5
- 8: 2.5

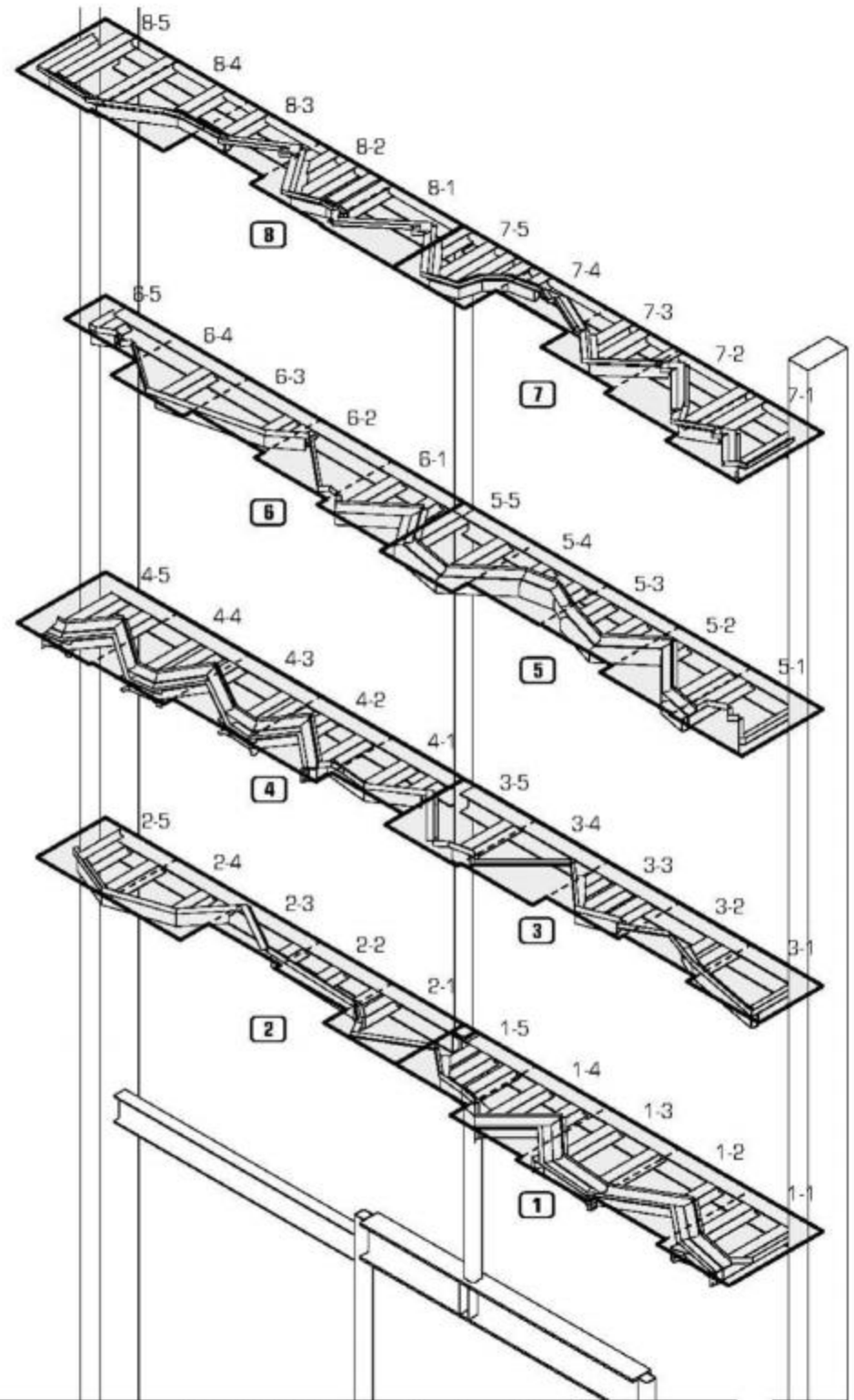

ISOMETRIC VIEW - Structural Steel Templates
Scale: n/a

4
A715

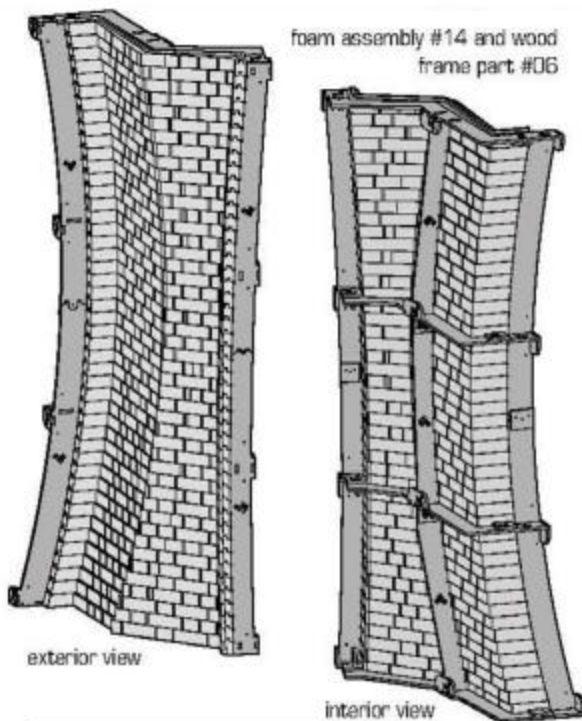

ISOMETRIC VIEW - Assembly
Scale: n/a

3
A717

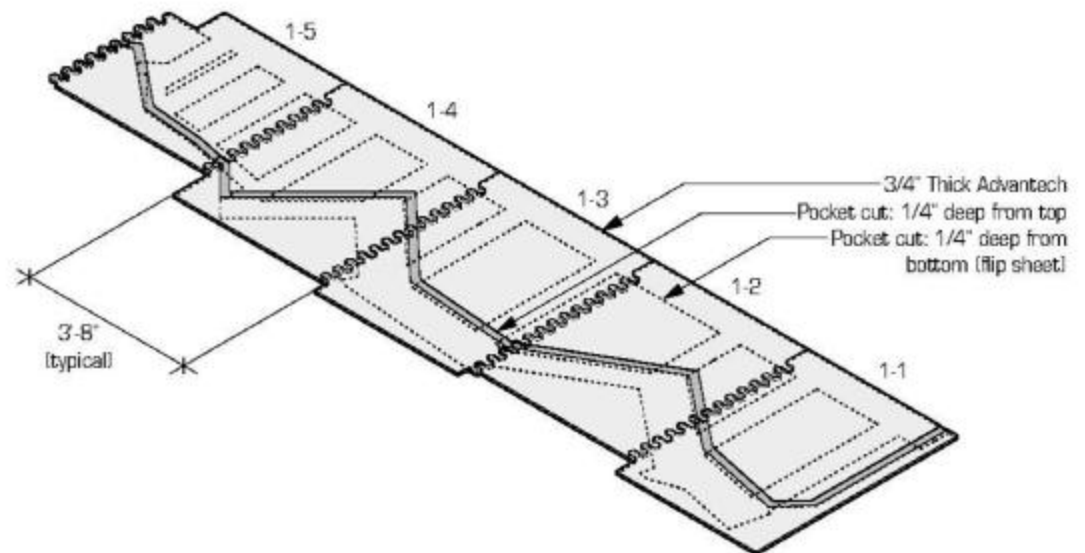

ISOMETRIC VIEW - Assembly 1 Structural Steel Templates
Scale: 3/8" = 1'-0"

1
A715

The rigid foam templates are arranged and assembled across the facade. The components waterproof, insulate, and attenuate sound. The whole is composed of 54 divisions made from stacked EPS foam and dovetail-notched plywood.

Four structural steel assemblies anchor the facade. The shapes are constructed using CNC milled wood templates.

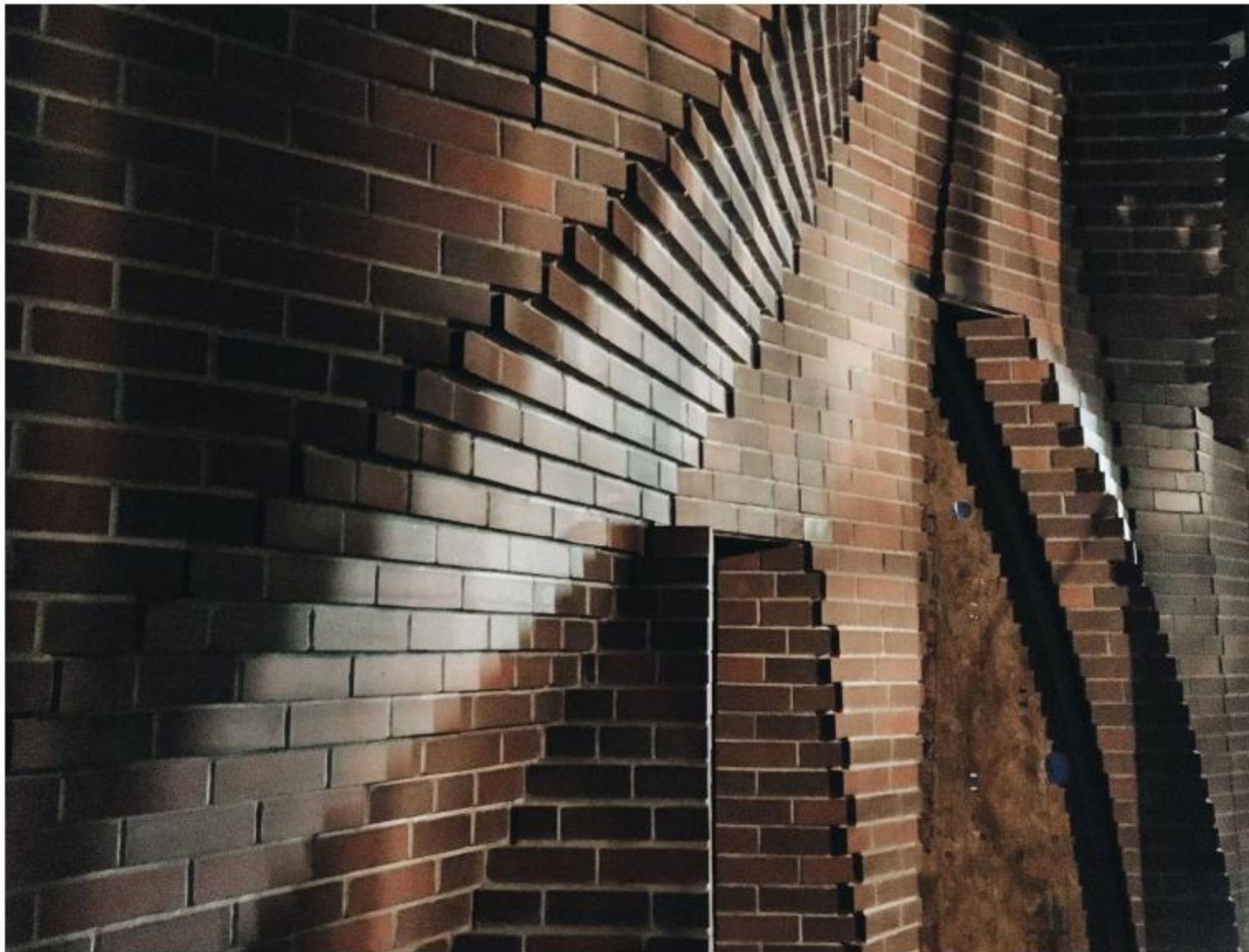



Brick is to be hand-laid on site against a permanent assembly template made of rigid foam. The template is CNC cut to form every brick course, and inscribes the position of each individual brick. The foam in turn insulates, helps with the waterproofing, and prevents damage from condensation between the walls. Furthermore, this thickened barrier eliminates street noise.

I was responsible for constructing the budget, updating the construction schedule, and composing the contract. For twelve months, I coordinated construction and supervised the site jointly with the contractor. My role is to ensure that the building transitions from fabrication files and digital models to material existence as was intended by the architects. I am comprehensively involved in the realization of this design.

guggenheimKANJONI

SYSTEMarchitects Llc.

2014

Finland is a land perforated by lakes and rivers. Those lakes and rivers are further perforated by islands. These boundaries between water and land, wilderness and civilization, shape the entire country: not just in the gentle curves of the actual geologic features, but in the ways that roads must bend, forests grow, and cities evolve in response to them. And this pervasive, shifting interplay shapes the imagination of the Finnish people as thoroughly as it shapes their physical world. The project doesn't just mimic but magnifies the experience of the Finnish landscape, through a concentration on that landscape's two most striking features: the perforations of water and land, and the rare but exquisite northern light.

The group of interlocking building forms are connected by public paths of circulation that draw in foot traffic from ferries, trams, roads, and sidewalks, much like the rivers that connect Finland's lakes. But the twisting geometry is also calculated to flood the "river valleys" with direct light as the sun moves through the sky in all seasons, turning the entire site into a celestial clock.

The surface of the site itself is perforated, and out of these perforations grow features resembling reeds, or great Finnish timber, reaching through the floor to support the roof. Built on pontoons, these supports rise and fall with the Helsinki tides, as does the roof itself, providing constant incremental shifts in motion and light, which falls through the roof in dappled patterns reminiscent of the light through trees in the Finnish wilderness.

These roof perforations are precisely calculated relative to the angle of the sun not just on each day, but for every moment of each day, to draw in the maximum light possible based on the orientation of the building to the sun. The resulting changes in light are dramatic: when visitors leave a room, the light will be noticeably different than when they entered. The shafts of light that fall through these perforations highlight the fact that urban spaces can also be a form of wilderness, as they create divisions in the space that are recognizably urban, but, because of their irregular edges, still wild. The surfaces of the building itself are reminiscent both of Finland's jagged geologic edges of river, sea, rock, and of the smooth curves of the Finnish roads that lead through them, with the same light creating different effects as it falls on the jagged or the smooth.

Program:

Exhibition Galleries 3,920 sq meters (56% net area)
Flexible Performance/Conference Hall 500 sq meters
Multifunction Classroom/Laboratory 65 sq meters
Project Space and/or Atrium 300 sq meters
Visitor Services 190 sq meters
Retail 300 sq meters
Dining 700 sq meters
Offices 500 sq meters
Collections Storage and Management 350 sq meters
Maintenance and Operations 230 sq meters
Unassigned Areas: Lobbies, Circulation, Restrooms, MEP, Loading Dock 5,045 sq meters

Total Gross Area: 12,100 sq meters
Overall Site Area: 18,520 sq meters

Jeremy Edmiston, Rob Baker, Anne Baker,
collaborators

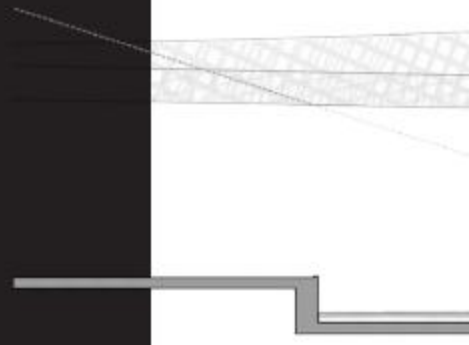
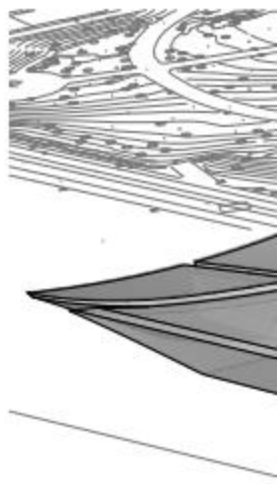
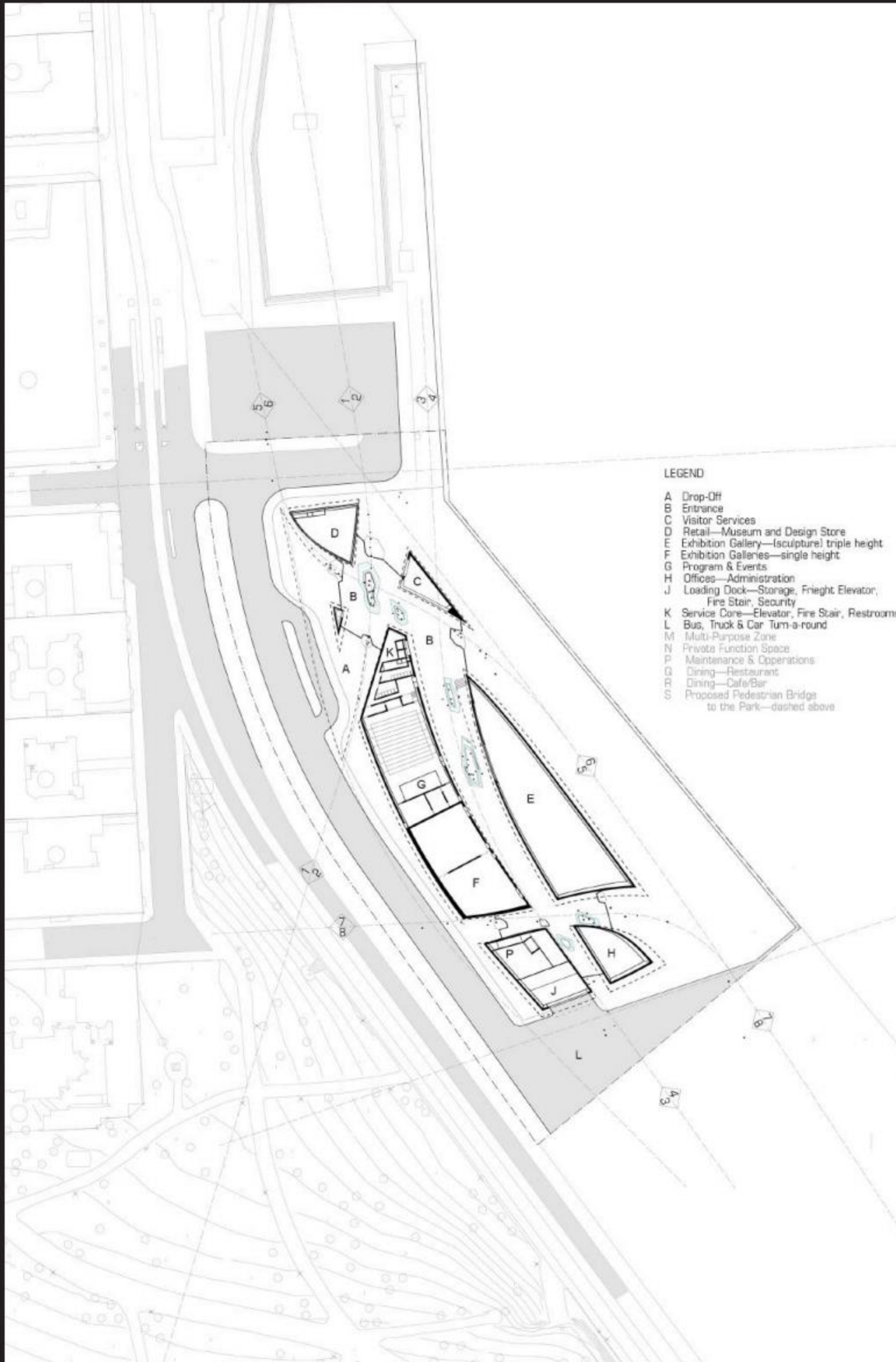

The
Abc
can

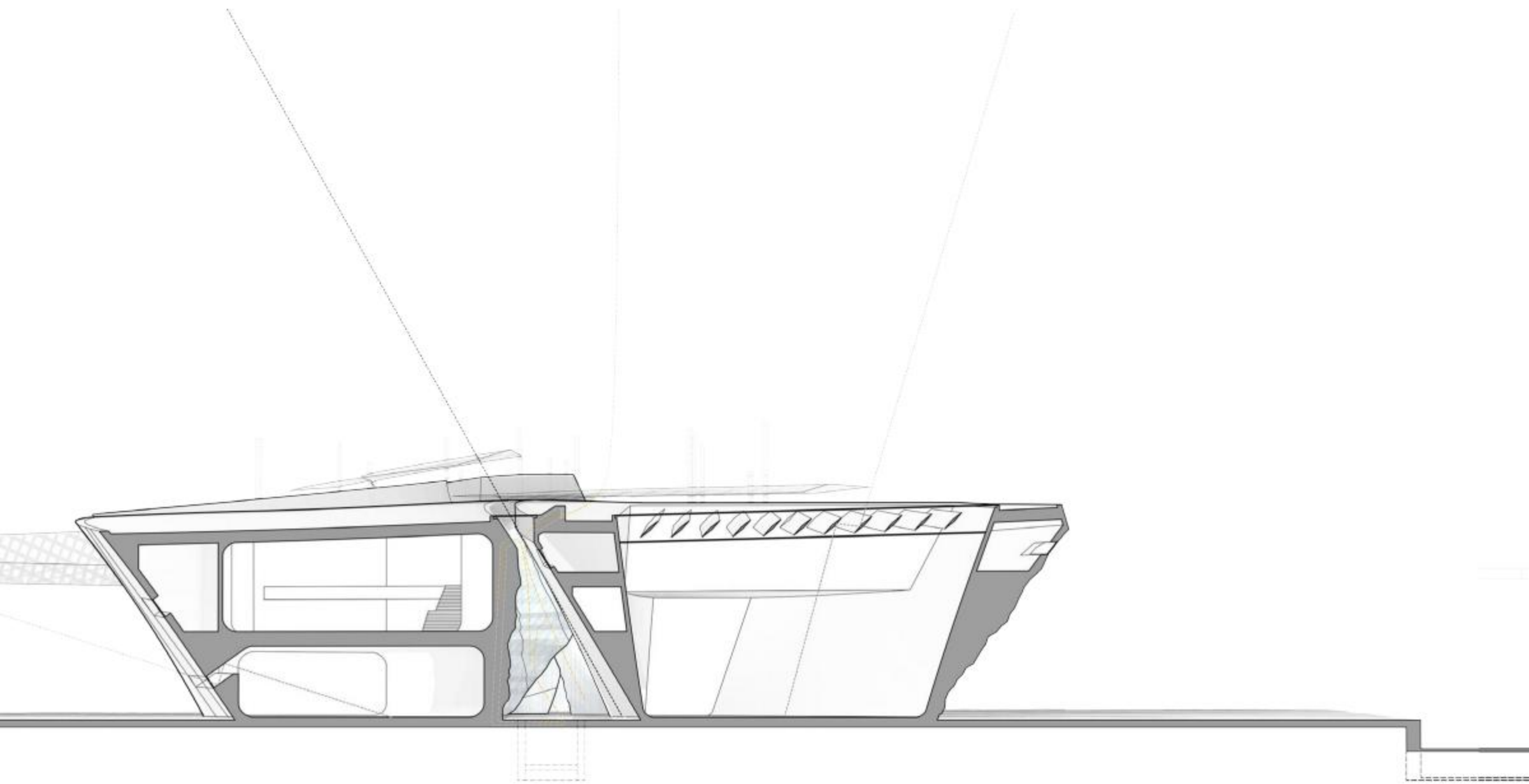
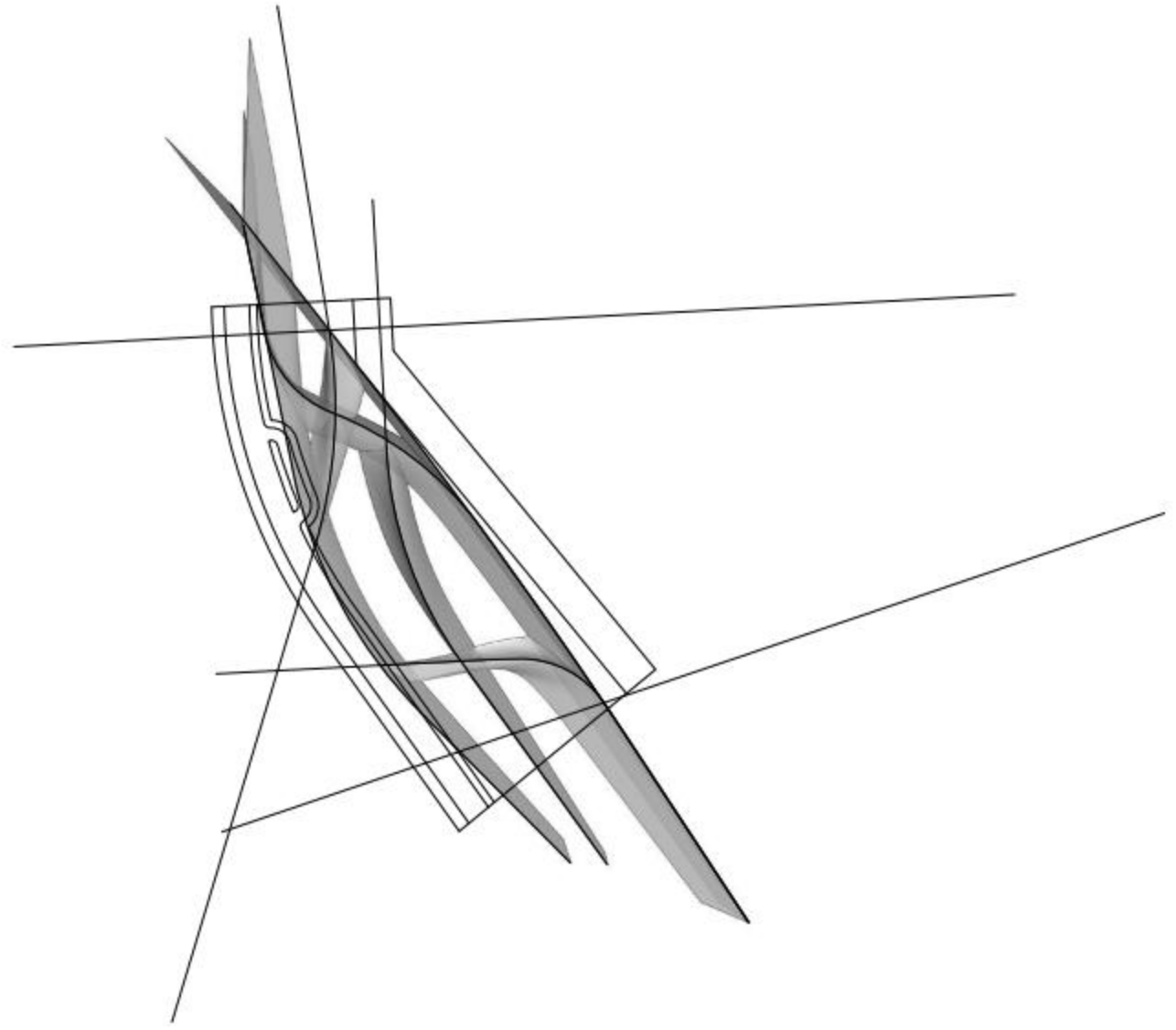
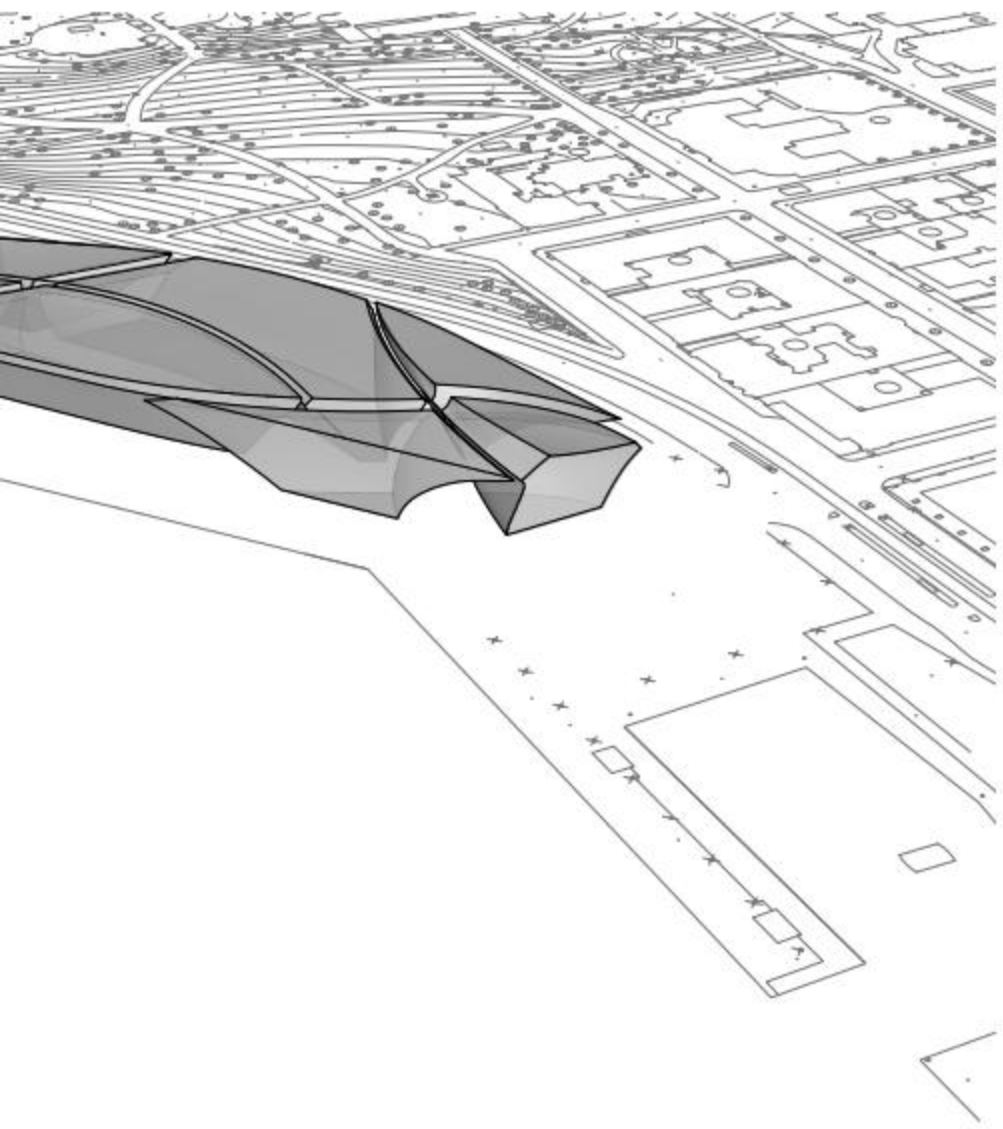

The built form is made by the river valleys. As they carve through the site they become canyons illuminated by shafts of light. Above: the form of these valleys is rendered, leaving the programmed space void. These forms maximize direct winter sun. The canyons are the public circulation and arranging system across the site.

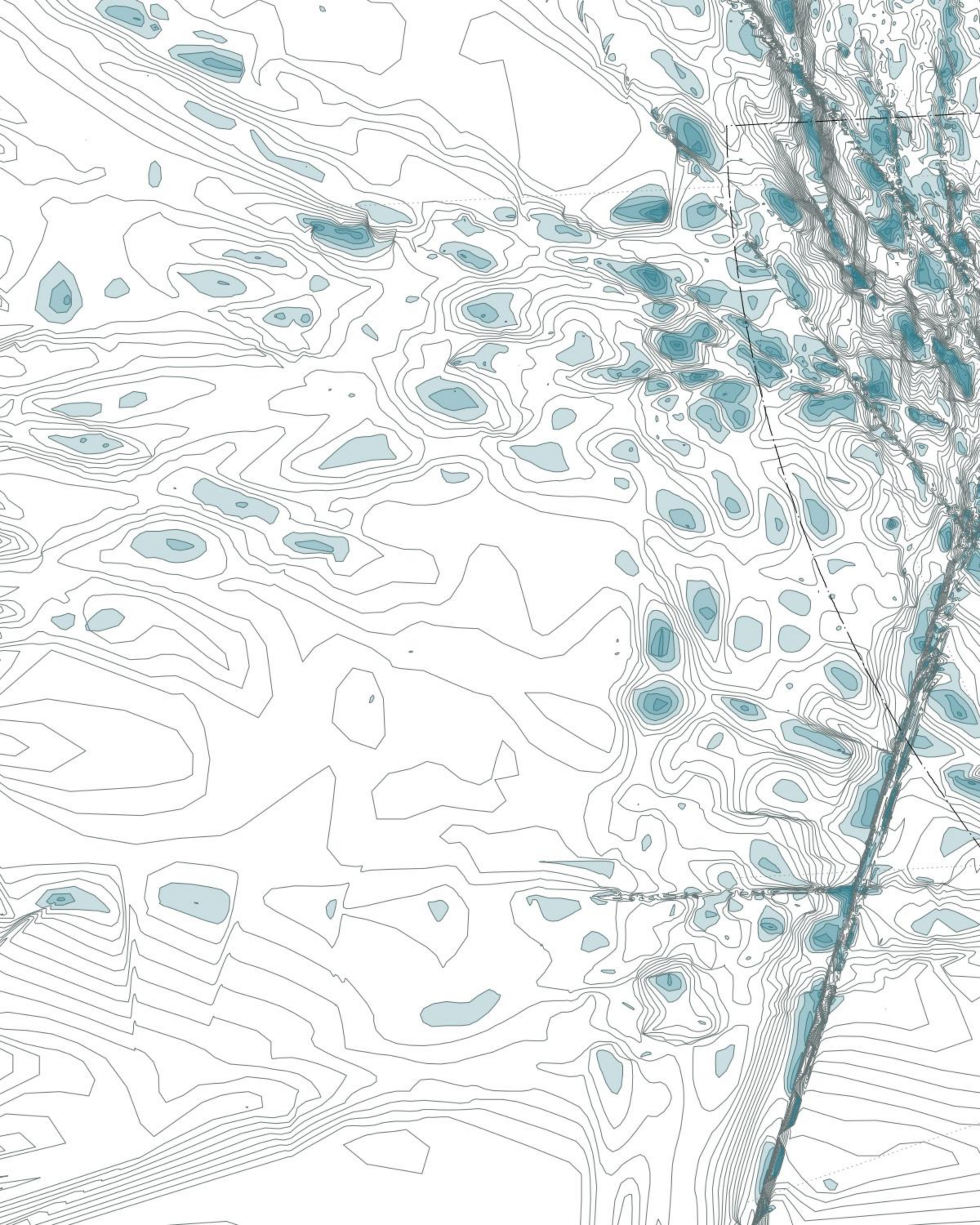

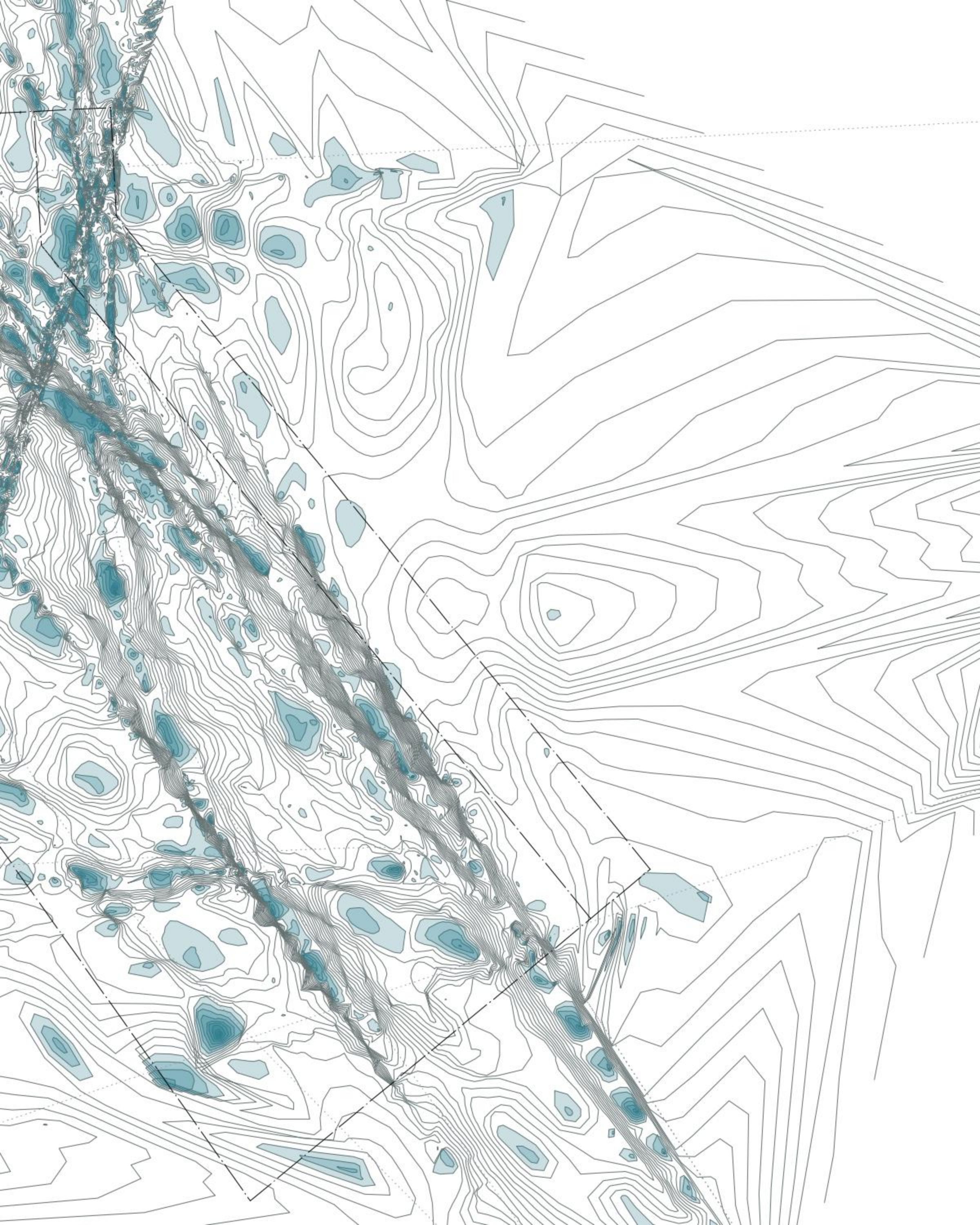

HIGH DENSITY URBAN



ORDER

Yale School of Architecture

H.I Feldman Prize Nominee

Spring 2016 Semester

CTBUH International Student Tall Building Design Competition: Second Prize
eVolo 2017 Skyscraper Competition: Honorable Mention

Bishopsgate Goodsyards is the largest remaining undeveloped piece of land in central London, however it is not vacant. Currently occupied by a massive brick viaduct and bisected by an Overground rail line, the Bishopsgate Goodsyards is a unique opportunity for density and diversity to redefine the conventions of the typical skyscraper while addressing the distinct character of the site.

The project is organized into four main components: a high-density tower, a mid-rise neighborhood, a train station that bridges between the two, and a park landscape that mediates between the existing viaduct and the various access points throughout the site. Each of the four components are given their own unique character, and by blending them into a continuous field they produce a differentiated system that accommodates diverse and overlapping programs at a hyper dense urban scale.

Early material studies focused on bifurcation and bundling techniques to visualize complex mathematical formulas, exploring potential moments of density versus open and loose strands that suggested larger voids or spaces.

The concentrated array of towers allows for a closer proximity between each high-rise while maintaining significant views, light, and air. These towers converge and diverge – floor plates connect and split apart – addressing the diversity of uses occurring within the tower through scalar shifts in the available area – from residential units to hotel units, corporate offices to start-ups, large retail stores to quiet cafés. This layering of buildings and programs causes the silhouette of the project to change from every perspective – its appearance is never the same from any two angles in the city - it is curious, ethereal, and poised.

The blending of four distinct architectural typologies addresses a diversity of urban functions, from living, working, recreation, and transportation. Respectful of its greater surroundings, this proposal creates a distinct sense of place in the city of London, a significant contribution to her public realm for pedestrians and city alike.

Lisa Albaugh, Benjamin Bourgoin, Roberto Jenkins, Justin Oh, collaborators

Zaha Hadid + Patrik Schumacher with Simon Kim + Lasha Brown, critics

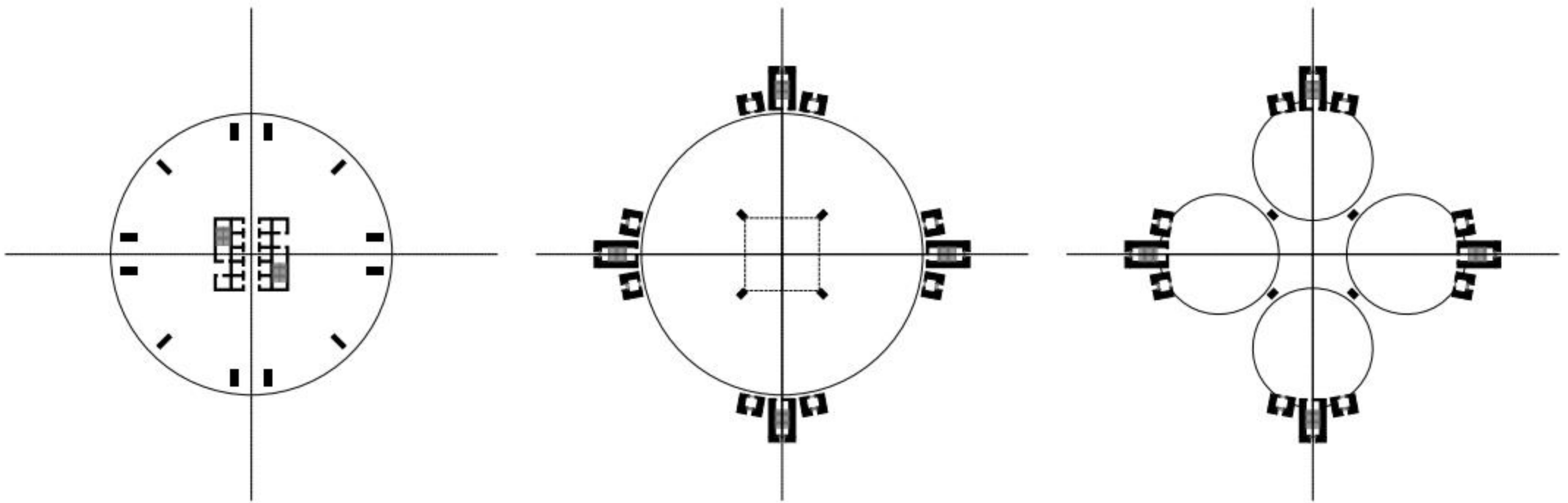

This project decentralizes the typically bulky tower core into finer perimeter elements. By rearranging the crucial tower components to the exterior – structure, elevators, stairs, and mechanical systems - the tower facade is instead articulated by the elements that are so often hidden away, creating a distinct appearance from street level and against the urban skyline.



This project breaks the convention of the internationalist, ubiquitous, object-like skyscraper by instead creating a high-resolution complex that is at once individual and collective as a field of pencil towers blending seamlessly between one another – creating a new and iconic urban order as an archetype for London's continued growth.



Upper Ground Level Plan (+6m)

- 1 High-Density Tower
- 2 Mid-Rise Typology
- 3 Bridged Train Station
- 4 Park Landscape + Existing Viaduct

London's skyline can be thought of as a collage city – where the unique individuality of each tower prevents it from engaging with the urban scale of its surroundings. This divergent urban order is neither unique to London nor a condition that will diminish without careful and direct intervention. Our project seeks to address this collage condition by creating a complex that is at once individual and collective as a field of pencil towers blending seamlessly between one another.

The blending of four distinct architectural typologies addresses a diversity of urban functions, from living, working, recreation, and transportation. Respectful of its greater surroundings, this proposal creates a distinct sense of place in the city of London, a significant contribution to her public realm for pedestrians and city alike.







SENSE OF PLACE

[1] Occupants and visitors are welcomed into a grand lobby to connect to various upper-level sky lobbies, the train station, or the park beyond.

[2] The quadruple-oculi frames the existing neighborhood of Shoreditch, the park, and the high-rise canyon formation along the Overground rail-line.

[3] Understanding the presence and rhythm of the existing brick viaduct on site, this project provides a new and contemporary metric loyal to the old.

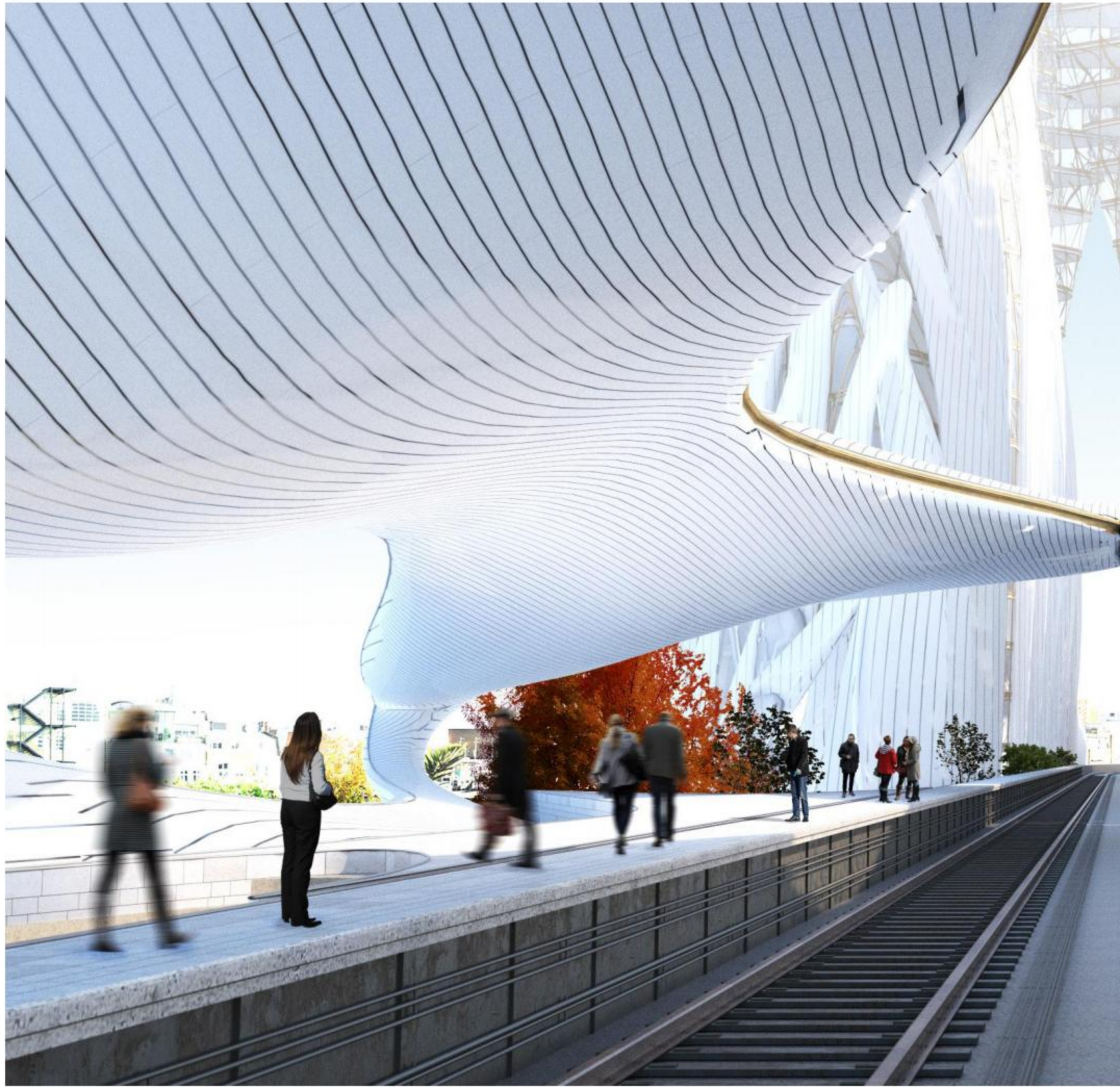

The train station celebrates the currently neglected piece of urban infrastructure, creating a new landmark amongst the towers.





External structure detaches from the tower proper in the form of buttresses, breaking down the scale of the high-rise as it meets the ground. The buttresses funnel pedestrians into the tower lobby, into the park landscape, and train station beyond.

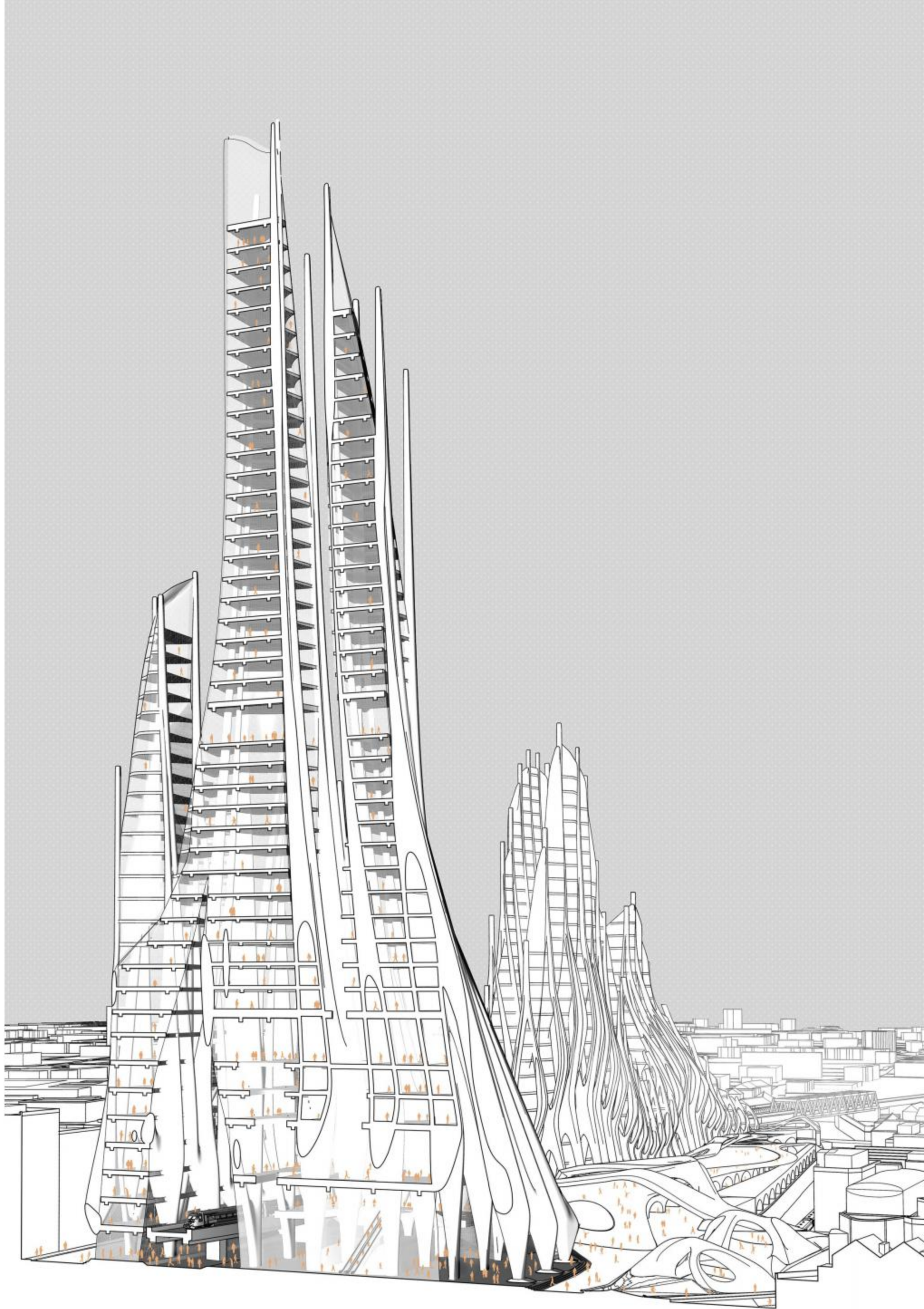



The concentrated “bundling” of towers allows for a closer proximity between each high-rise while maintaining significant views, light, and air. These towers converge and diverge – floor plates connect and split apart – addressing the diversity of uses occurring within the tower through scalar shifts in the available area – from residential units to hotel units, corporate offices to start-ups, large retail stores to quiet cafés. This layering of buildings and programs causes the silhouette of the project to change from every perspective – its appearance is never the same from any two angles in the city - it is curious, ethereal, and poised.



Typical Upper Level Plan (+18m)

- 1 High-Density Tower
- 2 Mid-Rise Typology
- 3 Bridged Train Station
- 4 Park Landscape + Existing Viaduct

